

# Report of Preliminary Geotechnical Investigation

## Neptune Road PD&E Study

FPID: 445415-1

PS-18-9905-DG

ETDM: 14402

Federal Aid Project Number: N/A

Prepared for:



**Osceola County, Florida**  
**Department of Transportation and Transit**  
**1 Courthouse Square, Suite 3100**  
**Kissimmee, FL 34741**

**MARCH 11, 2019**  
**REVISED DECEMBER 4, 2019**

Prepared by:  
Geotechnical and Environmental Consultants, Inc.  
In Association with:  
Kimley-Horn and Associates, Inc.

**TABLE OF CONTENTS**

Section	Page
TABLE OF CONTENTS.....	i
LIST OF TABLES.....	ii
LIST OF FIGURES.....	ii
APPENDIX.....	ii
1.0 PROJECT OVERVIEW.....	4
1.1 Introduction.....	4
1.2 Project Description.....	4
1.3 Purpose and Need.....	5
2.0 REVIEW AVAILABLE DATA.....	5
2.1 USGS Quadrangle Maps.....	6
2.2 NRCS Soil Survey Review.....	6
2.3 FDEP Potentiometric Data.....	8
2.4 Previous Geotechnical Investigation.....	8
3.0 PRELIMINARY SUBSURFACE EXPLORATION.....	8
3.1 Stormwater Ponds.....	8
3.2 Boring Locations.....	9
3.3 Groundwater Measurement.....	9
3.4 Manual Muck Probes.....	9
4.0 LABORATORY TESTING.....	10
5.0 DESCRIPTION OF SUBSURFACE CONDITIONS.....	10
5.1 Roadway and Pond 2A Soil and Groudwater Conditions - 2009 Investigation.....	10
5.2 Stormwater Pond Soil Stratigraphy.....	11
5.3 Stormwater Pond Soil Boring and Manual Muck Probe Results.....	11
5.4 Stormwater Pond Groundwater Levels.....	12
6.0 PRELIMINARY CONCLUSIONS AND RECOMMENDATIONS.....	13
6.1 Roadway.....	13
6.2 Stormwater Ponds.....	14
7.0 USE OF THIS REPORT.....	14

## REPORT

### List of Figures

---

Figure 1	Project Location
Figure 2	Project Limits

### List of Tables

---

Table 1	Summary of NRCS Soil Survey Units
Table 2	Summary of Laboratory Testing Program
Table 3	Soil Stratigraphy
Table 4	Summary of Manual Muck Probe Results
Table 5	Summary of Groundwater Levels
Table 6	NRCS Summary of Groundwater Levels

## APPENDIX

### List of Figures

---

Figure 3	USGS Quadrangle and NRCS Soil Survey Maps
Figures 4A – 4E	Boring and Probe Location Plan
Figure 5	Roadway Soil Survey
Figure 6	Pond Boring Results

### List of Tables

---

Table 7	Summary of Laboratory Test Results
---------	------------------------------------

2009 Roadway Soil Survey - Roadway and Pond Boring Results

## 1.0 PROJECT OVERVIEW

### 1.1 INTRODUCTION

The Neptune Road PD&E Study project is located within unincorporated Osceola County and the City of St. Cloud, Florida as shown on **Figure 1**. To facilitate project development, published soil and groundwater information was reviewed along the project alignment. In addition, soil and groundwater information was obtained from soil borings and manual probes to help evaluate alternative stormwater pond locations. The purpose of this report is to describe our investigation methodology, present the soil and groundwater information obtained and provide preliminary recommendations regarding the geotechnical engineering aspects of project development.

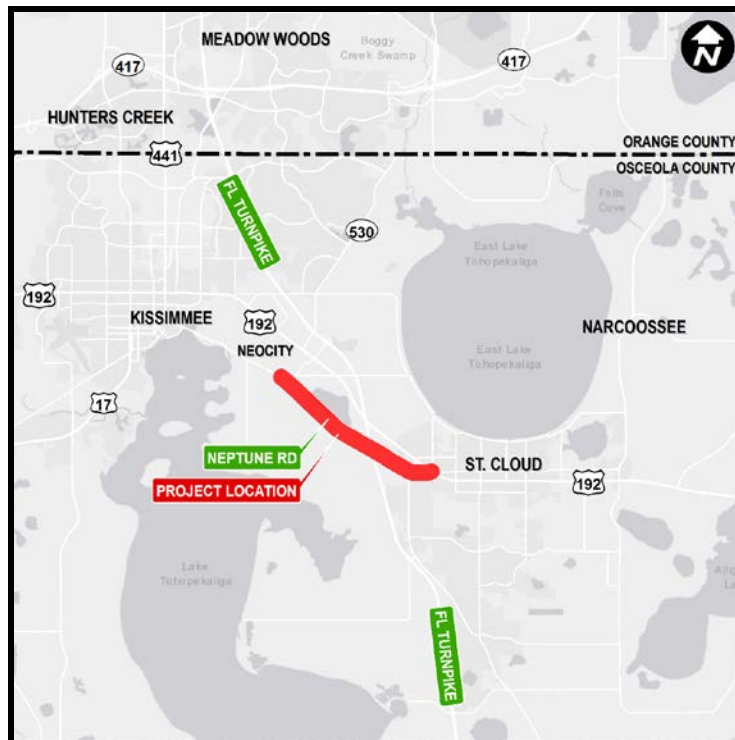
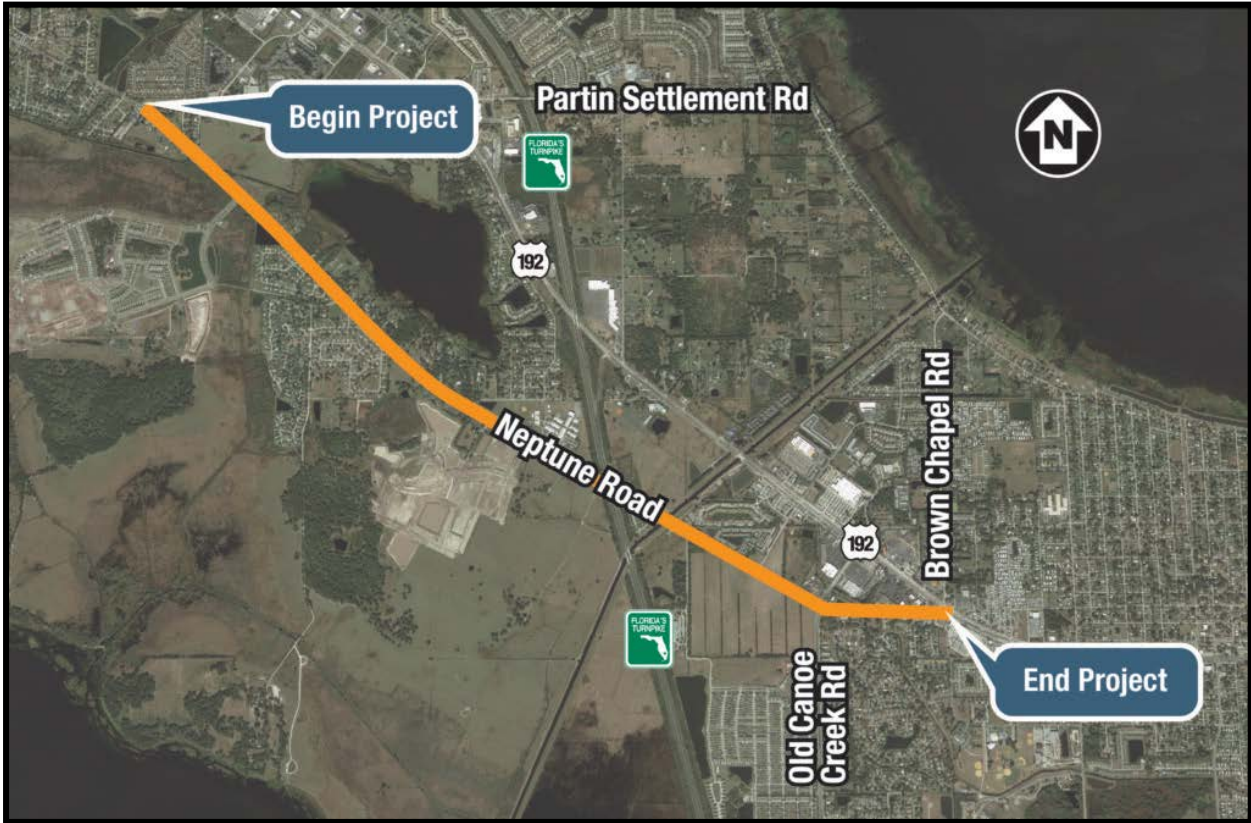

**Figure 1: Project Location**

### 1.2 PROJECT DESCRIPTION

This project involves a 3.9-mile segment of Neptune Road extending from Partin Settlement Road to US 192 in Osceola County as illustrated on **Figure 2**. The section east of the St. Cloud/C-31 canal (approximately 1.1 miles in length) is within the City of St. Cloud. From Partin Settlement Road to Old Canoe Creek Road, the proposed project improves the existing 2-lane roadway to a 4-lane, divided roadway with a curbed median, with premium bicycle and pedestrian facilities (i.e., bike lanes, multiuse paths and/or sidewalks). From Old Canoe Creek Road to US 192, the project widens the existing 2-lane roadway to either 4-lanes or 5-lanes with a multiuse path on the north side and a sidewalk on the south side. Bridge structures are to be replaced and stormwater management facilities will be evaluated.

Figure 2: Project Limits



Land use along Neptune Road is primarily residential. Neptune Middle School is located on the north side of the road, west of Florida's Turnpike. Some commercial development is present east of the St. Cloud Canal.

### 1.3 PURPOSE AND NEED

The primary purpose of improving Neptune Road is to enhance mobility from US 192 and St. Cloud to Downtown Kissimmee, improve access to NeoCity, and improve overall traffic operations of the existing highway network within the project study area. The secondary objectives are to provide transportation infrastructure to support economic growth, provide consistency with local plans and policies, and enhance safety.

The need for the project is to provide system linkage, provide additional capacity, address transportation demand, meet social and economic needs, provide improved modal interrelationships, improve safety and achieve consistency with transportation plans.

### 2.0 REVIEW OF AVAILABLE DATA

To obtain general information on soil and groundwater conditions along the project alignment, GEC reviewed available data including USGS Quadrangle Map, the Natural Resources Conservation Service (NRCS) Soil Survey of Osceola County as shown on **Figure 3** in the **Appendix**, as well as other published sources. **Figure 3** shows the roadway alignment and ten alternative stormwater pond locations. Seven

locations were evaluated during this study (Pond 1A, 1B, 2A, 2B, 2C, 3A, 3B, 4A, 4B and 5). The remaining three pond sites (3A, 3B and 4B) were later added after drilling operations were complete. A summary of the map information is presented in the following report sections.

## **2.1 USGS QUADRANGLE MAPS**

Based on our review of the St. Cloud North, and St. Cloud South, Florida Quadrangle maps, the existing ground surface elevation varies from about +60 ft NGVD to +70 ft NGVD along the roadway alignment. Ground surface elevations at the alternative stormwater pond locations are summarized below:

- Pond 1A: +55 to +60 feet NGVD
- Pond 1B: +60 to +65 feet NGVD
- Pond 2A: +60 to +65 feet NGVD
- Pond 2B: +60 to +65 feet NGVD
- Pond 2C: +65 to +70 feet NGVD
- Pond 3A: +60 to +62 feet NGVD
- Pond 3B: +60 to +62 feet NGVD
- Pond 4A: +60 to +65 feet NGVD
- Pond 4B: +60 to +65 feet NGVD
- Pond 5: +60 to +65 feet NGVD

Site features within the project corridor include the following:

- The Partin Canal near the project beginning at Partin Settlement Road.
- Low-lying marshlands and associated drainage-ways cross Neptune Road south of Fish Lake.
- Former orchard/citrus groves in the central and eastern portions of the project.
- The St. Cloud/C-31 Canal near the project end at US 192.
- Florida's Turnpike crosses under Neptune Road west of the St. Cloud Canal.

## **2.2 NRCS SOIL SURVEY REVIEW**

The Natural Resources Conservation Service (NRCS) Soil Survey of Osceola County, Florida was reviewed for near-surface soil and groundwater information. The soils along the roadway and within the stormwater pond locations are summarized in **Table 1**.

**Table 1: Summary of NRCS Soil Survey Soil Units**

Soil Unit No.	Soil Name	Depth (inches)	Soil Description	AASHTO Classification Symbol	Depth to Seasonal High Groundwater (feet)	Hydrologic Group
1	Adamsville sand, 0 to 2 percent slopes	0 – 4 4 – 33 33 – 80	Sand Sand, fine sand Fine sand, sand	A-3, A-2-4 A-3, A-2-4 A-3, A-2-4	1.5 – 3.5	A
5	Basinger fine sand, 0 to 2 percent slopes	0 – 80	Fine sand	A-3, A-2-4	0.5 – 1.5	A/D
10	Delray loamy fine sand, depressional	0 – 14 14 – 44 44 – 62 62 – 80	Loamy fine sand Fine sand Fine sandy loam, sandy clay loam Loamy fine sand, fine sandy loam	A-3, A-2-4 A-3, A-2-4 A-2-4, A-2-6 A-3, A-2-4	+2.0 – 0.0	A/D
16	Immokalee fine sand	0 – 54 54 – 80	Fine sand Fine sand, loamy fine sand, sand	A-3, A-2-4 A-3, A-2-4	0.5 – 1.5	B/D
22	Myakka fine sand, 0 to 2 percent slopes	0 – 6 6 – 80	Fine sand Fine sand, sand	A-3, A-2-4 A-3, A-2-4	0.5 – 1.5	A/D
32	Placid fine sand, frequently ponded, 0 to 1 percent slopes	0 – 24 24 – 80	Fine sand Fine sand, sand	A-3, A-2-4 A-3, A-2-4	+2.0 – 0.0	A/D
40	Samsula muck, frequently ponded, 0 to 1 percent slopes	0 – 32 32 – 80	Muck Sand, fine sand	A-8 A-3, A-2-4	+2.0 – 0.5	A/D
42	Smyrna fine sand, 0 to 2 percent slopes	0 – 80	Fine sand	A-3, A-2-4	0.5 – 3.3	A/D
45	Wabasso fine sand, 0 to 2 percent slopes	0 – 32 32 – 48 48 – 80	Fine sand Fine sandy loam, sandy clay loam Fine sandy loam, loamy fine sand, fine sand	A-3, A-2-4 A-2-4, A-6 A-2-4, A-4	0.5 – 1.5	A/D
46	Wauchula fine sand	0 – 28 28 – 41 41 – 54 54 – 80	Fine sand Loamy fine sand, fine sand Fine sandy loam, sandy clay loam Fine sandy loam, loamy fine sand	A-3, A-2-4 A-3, A-2-4 A-2-4, A-2-6, A-4, A-6 A-2-4, A-2-6	0.5 – 1.5	A/D

The NRCS soil survey map generally depicts gently sloping, depressional fine sand soils with variable silt content fines (A-3, A-2-4) in the Neptune Road corridor. These soils are generally underlain by loamy fine sand to sandy loam (A-2-6, A-4, A-6) soil types. The NRCS predicts seasonal high groundwater levels for these soil types to range from 2 feet above the natural ground surface (ponded) to 3.5 feet below the natural ground surface.

The NRCS map depicts Samsula muck (Soil Unit No. 40) in the western portion of the alignment and along the southern limit of Pond 2A. This soil type contains high organic content soils (A-8), which can have severe limitations for roadway construction if left untreated.

*Information contained in the NRCS Soil Survey is very general and may be outdated.* Therefore, it may not be reflective of actual soil and groundwater conditions, particularly if recent development in the site vicinity has modified soil conditions or surface/subsurface drainage. The information obtained from recent soil borings provides a better characterization of actual site conditions.

### **2.3 FLORIDAN AQUIFER POTENTIOMETRIC DATA**

The Florida Department of Environmental Protection (FDEP) September 2016 Potentiometric Contours map shows the potentiometric surface of the Floridan Aquifer at approximately +48 feet NGVD along the roadway corridor. Based on review of the USGS Quadrangle map data, the ground surface elevations at the site ranges between +55 to +70 feet NGVD. Since the ground surface elevation is above the potentiometric surface, and the clay confining layer is very thick and competent, artesian conditions are not anticipated.

### **2.4 PREVIOUS GEOTECHNICAL INVESTIGATION**

GEC conducted a geotechnical investigation for Neptune Road in 2009. Due to lack of property owner permission to conduct borings at the Pond 2A location, the previous borings performed at this pond location (formerly Pond 200) were used in this investigation. Twenty-five auger borings (PB-16 to PB-30 and PB-40 to PB-49) were performed to a depth of 20 feet in Pond 200. Roadway auger borings were performed to depths ranging from 2 to 15 feet below the ground surface on approximate 100-foot intervals along the project alignment. High fill SPT borings were performed to depths ranging from 15 to 30 feet below the ground surface on approximate 100-foot intervals. The boring locations and soil boring logs summarized above are included in the **Appendix**. For complete details of the previous geotechnical study, please refer to the 60% Report of Roadway Soil Survey dated January 29, 2009.

## **3.0 PRELIMINARY SUBSURFACE EXPLORATION**

In addition to consulting the sources of information previously discussed for regional and site-specific soils data, GEC conducted a subsurface exploration to evaluate soil and groundwater conditions at the alternative stormwater pond locations as detailed in the follow report sections.

### **3.1 STORMWATER PONDS**

Subsurface conditions at the seven alternative stormwater pond locations were evaluated by performing auger borings to a typical depth of 15 feet. Soil borings were not performed for Ponds 3A, 3B and 4B as they were later added. Manual muck probes were also performed at locations with ponded water. The borings and muck probes were distributed among the pond sites as follows:

- Pond 1A: Two borings (AB-1 to AB-2) and 1 muck probe (MP1A-1)
- Pond 1B: One boring (AB-4) and 3 muck probes (MP1B-1, MP1B-2 and MP1B-3)



- Boring AB-3 was unable to be performed due to construction activities
- Boring AB-5 was unable to be performed due to a wet detention pond
- One boring was performed as manual muck probe (MP1B-3) due to ponded water
- Pond 2A: Site was inaccessible due to property owner. Boring data from the GEC 60% Report of Roadway Soil Survey dated January 2009 was utilized for this pond site (previously identified as Pond 200) and is included in the **Appendix**.
- Pond 2B: Two borings (AB-9 to AB-10)
- Pond 2C: Two borings (AB-11 to AB-12)
- Pond 3A: Pond site added after field investigation was completed; no borings performed at this location.
- Pond 3B: Pond site added after field investigation was completed; no borings performed at this location.
- Pond 4A: Two borings (AB-13 to AB-14) and 1 muck probe (MP4-1)
- Pond 4B: Pond site added after field investigation was completed; no borings performed at this location.
- Pond 5: Two borings (AB-15 to AB-16)

### **3.2 BORING LOCATIONS**

Boring and muck probe locations were not established by survey, but rather by using project plans and a handheld, sub-meter accuracy, Global Positioning Satellite (GPS) unit. Although the boring and muck probe locations are only approximate, the methods used to locate them are, in GEC's opinion, sufficient to meet the intent of this study.

### **3.3 GROUNDWATER MEASUREMENT**

A GEC engineering technician measured the depth to the groundwater in the boreholes at the time of drilling and again after approximately 24 hours. Once the groundwater measurements were recorded, the boreholes were backfilled with soil cuttings to prevailing ground surface.

### **3.4 MANUAL MUCK PROBES**

Manual muck probes were performed by pushing a slender metal rod into the surficial soil and evaluating the relative resistance of the soil to manual penetration. Highly organic soils, such as muck and/or peat, are characteristically very soft and will easily yield to the manual probe. Manual probes, however, cannot detect peat or muck layers which are present beneath layers of sand or dense soils which cannot be penetrated by the probe. The probes can also penetrate to some extent in very loose sands which may be present beneath peat or muck layers. No soil samples are obtained for visual examination or laboratory testing when using this exploratory technique. The soil type being penetrated is inferred solely by evaluating the relative resistance of the soil to penetration. These limitations can lead to some under-estimation or over-estimation of peat or muck layer thicknesses. The probe data presented in this report should be evaluated with these limitations in mind.

#### 4.0 LABORATORY TESTING

Selected soil samples retrieved from the borings were tested in accordance with Florida Standard Testing Methods (FM) and AASHTO test methods. Florida Standard Testing Methods are adaptations of recognized standard methods, e.g., ASTM and AASHTO, which have been modified to accommodate Florida’s geological conditions. The GEC laboratory has been reviewed by the Construction Materials Engineering Council (CMEC). The laboratory testing program for this project is summarized in **Table 2**:

**Table 2: Summary of Laboratory Testing Program**

Type of Test	Number of Tests
Grain Size Analysis (AASHTO-T88)	12
Natural Moisture Content (AASHTO-T265)	4
Atterberg Limits (AASHTO-T89/90)	3
Organic Content (FM 1-T267)	1

The results of our laboratory testing for the roadway borings are summarized on the Roadway Soil Survey sheet (**Figure 5**) and **Table 7** in the **Appendix**.

#### 5.0 DESCRIPTION OF SUBSURFACE CONDITIONS

The soils encountered in the borings were classified in accordance with the American Association of State Highway and Transportation Officials (AASHTO) Soil Classification System (A-3, A-2-4, etc.). Soils were described using the ASTM soil descriptions (e.g., sand with silt). We based our classifications on visual examination and the limited laboratory testing performed.

*The boring logs indicate subsurface conditions only at the specific boring and muck probe locations at the time of our field exploration. Subsurface conditions, including groundwater levels, at other locations of the project site may differ from conditions we encountered at the boring and muck probe locations. Moreover, conditions at the boring locations can change over time. Groundwater levels fluctuate seasonally, and soil conditions can be altered by earthmoving operations.*

The depths and thicknesses of the subsurface strata indicated on the boring logs were interpolated between samples obtained at different depths in the borings. The actual transition between soil layers may be different than indicated. *These stratification lines were used for our analytical purposes and actual earthwork quantities measured during construction should be expected to vary from quantities calculated based on the information in this report.*

#### 5.1 ROADWAY AND POND 2A SOIL AND GROUNDWATER CONDITIONS – 2009 INVESTIGATION

The roadway auger borings from the 2009 study generally encountered fine sand with variable silt fines content (A-3, A-2-4) from the ground surface to a boring termination depth of up to 20 feet. Near surface to buried layers of mucky fine sand to sandy muck (A-8) soils were encountered to depths of up to 5.5 feet; primarily in the eastern portion of the Neptune Road corridor. Intermittent layers of clayey

fine sand to sandy clay (A-2-6, A-6) were encountered at depths ranging from 3 to 10 feet below the ground surface.

The Pond 2A subsurface profile was similar to the roadway soil profile described above. However, only a minor amount of muck (A-8) was encountered in one boring. The clayey fine sand to sandy clay layer (A-2-6, A-4, A-6) encountered ranged in depths from 5 to 20 feet below the ground surface.

The high fill embankment SPT borings typically encountered very loose to medium dense fine sand with varying silt and clay content fines (SP, SP-SM, SM, SC) to depths ranging from 15 to 30 feet with occasional trace organic material.

Groundwater levels in the roadway and pond borings typically ranged from +52.5 to +67.3 feet NGVD. Groundwater was not encountered (GNE) in a few roadway borings across the project alignment.

### 5.2 STORMWATER POND SOIL STRATIGRAPHY

The descriptions and stratum numbers used for the encountered soils are summarized as follows:

**Table 3: Soil Stratigraphy**

Stratum No.	Soil Description	AASHTO Classification
1	Light brown to brown to dark brown to gray to light gray fine sand to fine sand with silt, occasional trace limerock and asphalt fragments	A-3
2	Light brown to brown to gray fine sand with silt to silty fine sand, occasional limerock fragments	A-2-4
3	Brown to light brown to gray silty fine sand, occasional trace clay	A-2-4 (-200>20%)
4	Brown clayey fine sand	A-2-6, A-6
5	Dark brown mucky fine sand	A-8

### 5.3 STORMWATER POND SOIL BORING AND MANUAL MUCK PROBE RESULTS

The pond borings performed at the six pond sites explored for this study typically encountered fine sand with variable silt content (A-3, A-2-4) (Strata 1 and 2) to the boring termination depth of 15 feet. Occasional limerock and asphalt fragments were observed in the soil during drilling. Silty sand with high fines content [greater than 20% passing the no. 200 sieve] (A-2-4) (Stratum 3) was encountered at depths ranging from 3 to 15 feet below the ground surface. Intermittent layers of clayey fine sand (A-2-6, A-6) (Stratum 4) were encountered at depths ranging from 4 to 13 feet. Boring AB-4 (Pond 1B) encountered a near-surface layer of mucky fine sand (A-8) (Stratum 5) extending to a depth of 2.5 feet below the ground surface (measured organic content of 13%).

Manual muck probes were performed in ponded water to evaluate the presence of compressible organic sediments. A summary of the manual muck probe results is included in the following table:

**Table 4: Summary of Manual Muck Probe Results**

Location	Standing Water Depth (ft.)	Range of Estimated Surficial Organic Soil Thickness (ft.)
Pond 1A	8.5	0.0
Pond 1B	0.0	1.0
Partin Canal	3.0 – 4.0	0.5 – 1.5
Pond 4	11.0	0.0
Measured February 25, 2019		

**5.4 STORMWATER POND GROUNDWATER LEVELS**

Groundwater levels were measured at least 24 hours after completing the boring. Encountered, estimated seasonal high and average wet season groundwater levels are summarized in the table below:

**Table 5: Summary of Groundwater Levels**

Location	Encountered Groundwater Depth (ft.)	Estimated Seasonal High Groundwater Depths (ft.)	Average Wet Season Groundwater Depth (ft.)
Pond 1A	4.6 – 5.3	2.6 – 3.3	3.6 – 4.3
Pond 1B	2.3	0.5	1.5
<sup>1</sup> Pond 2A	2.4 – 6.9	0.4 – 4.9	1.4 – 3.9
Pond 2B	3.9 – 4.1	1.9 – 2.1	2.9 – 3.1
Pond 2C	3.1 – 5.9	1.1 – 3.9	2.1 – 4.9
Pond 4A	2.3 – 3.3	1.0 – 1.3	2.0 – 2.3
Pond 5	6.3 – 6.8	4.3 – 4.8	5.3 – 5.8
1. Measured groundwater depths referenced from GEC 2009 study.			

Soil borings were unable to be performed for Ponds 3A, 3B and 4B as they were added to the study after the field investigation was completed. Information from the NRCS Soil Survey was utilized to provide the soil types, estimated seasonal high and average wet season groundwater levels summarized in the table below:

**Table 6: NRCS Summary of Groundwater Levels**

Location	NRCS Soil Unit	NRCS Estimated Seasonal High Groundwater Depths (ft.)	Average Wet Season Groundwater Depth (ft.)
Pond 3A	10, 16	+2.0 – 1.5	+1.0 – 2.5
<sup>1</sup> Pond 3B	16	0.5 – 1.5	1.5 – 2.5
<sup>1</sup> Pond 4B	10	+2.0 – 0.0	+1.0 – 1.0
1. Groundwater levels likely influenced by the fluctuations of the C-31 canal and its operations.			

Groundwater levels can vary seasonally and with changes in subsurface conditions between boring locations. Alterations in surface and/or subsurface drainage brought about by site development can also affect groundwater levels. *Therefore, groundwater depths measured at different times or at different locations along the project alignment can be expected to vary from those measured by GEC during this investigation.*

For the purposes of this report, estimated seasonal high groundwater levels are defined as groundwater levels that are anticipated at the end of the wet season of a “normal rainfall” year under current site conditions. We define a “normal rainfall” year as a year in which rainfall quantity and distribution were at or near historical rainfall averages.

The encountered and estimated seasonal high groundwater levels at the boring locations are presented on the Pond Borings Results sheet (**Figure 6**) in the **Appendix**.

## **6.0 PRELIMINARY CONCLUSIONS AND RECOMMENDATIONS**

The preliminary conclusions and recommendations contained in this report are based in part on the data obtained from a limited number of soil samples and groundwater measurements obtained from widely-spaced borings. The investigation methods used indicate subsurface conditions only at the specific boring and probe locations, only at the time they were performed, and only to the depths penetrated. Borings and probes cannot be relied upon to accurately reflect the variations that usually exist between boring and probe locations and these variations may not become evident until construction.

### **6.1 ROADWAY**

The results of the 2009 GEC geotechnical investigation indicate the near-surface soils along the Neptune Road alignment were generally suitable for support of the proposed roadway construction. The soils encountered along the alignment classified as A-3 and A-2-4 should be treated as Select (S) material. The clayey fine sand to sandy clay (A-2-6, A-4, A-6) encountered should be treated as Plastic (P) material. The mucky fine sand to sandy muck (A-8) should be treated as Muck (M) and is not suitable for use as embankment fill.

## 6.2 STORMWATER PONDS

The soils encountered in the pond borings are typically Strata 1, 2 and 3 (A-3, A-2-4), which are suitable for use as Select (S) fill for roadway embankment construction. Stratum 2 and Stratum 3 (A-2-4) soils may retain excess moisture and be difficult to dry and compact during placement. Soils excavated below the water table will need to be dried to a moisture content near optimum to achieve the required degree of compaction. Soils excavated from the stormwater ponds should be placed in embankment areas in accordance with FDOT Standard Plans, Index 120-001.

The plastic soil in Stratum 4 has limitations for use in embankment construction as depicted in the FDOT Standard Plans. The mucky fine sand in Stratum 5 is weak and highly compressible and should not be used in embankment construction.

Soil borings will be required for Ponds 3A, 3B and 4B to verify the fill suitability for roadway embankment construction and establish groundwater levels for stormwater pond design.

Due to shallow groundwater levels, it appears wet detention ponds are the most feasible design option. For use in pond design within the South Florida Water Management District, the average wet season groundwater levels are estimated to be about 1 foot below the seasonal high groundwater level as shown in **Tables 5** and **6**. The measured groundwater table and estimated seasonal high groundwater levels at each pond boring location are shown on **Figure 6**.

## 7.0 USE OF THIS REPORT

GEC has prepared this report for the exclusive use of our client, Kimley-Horn and Associates, Inc., and Osceola County, and for specific application to this project. GEC will not be held responsible for any other party's interpretation or use of this report's subsurface data or contents without our written authorization.

The sole purpose of the borings and muck probes performed by GEC at this site was to obtain indications of subsurface conditions as part of a preliminary geotechnical exploration program. A Contamination Screening Evaluation Report (CSER) was submitted under separate cover to assess the risk of encountering contaminated soils and groundwater for this project.

GEC has performed the services described in this report in a manner consistent with that level of care and skill ordinarily exercised by members of our profession currently practicing in Central Florida. No other representation is made or implied in this document.

This preliminary investigation was intended to aid in project planning and development. A more detailed geotechnical investigation will be required to develop geotechnical engineering recommendations to guide roadway design and construction.



Kevin Baboolall, E.I.  
Engineer Intern

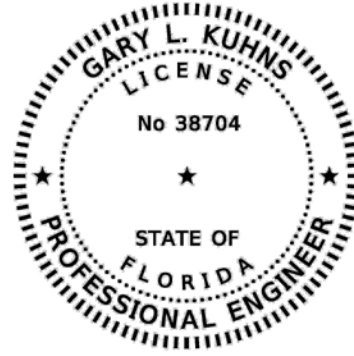

Gary L. Kuhns, P.E.  
President  
Florida License No. 38704

This Report has been digitally signed and sealed by Gary L. Kuhns, P.E. on the date adjacent to the seal. Printed copies of this document are not considered signed and sealed and the signature must be verified on any electronic copies.

**FIGURE 3**  
**USGS QUADRANGLE AND NRCS SOIL SURVEY MAPS**



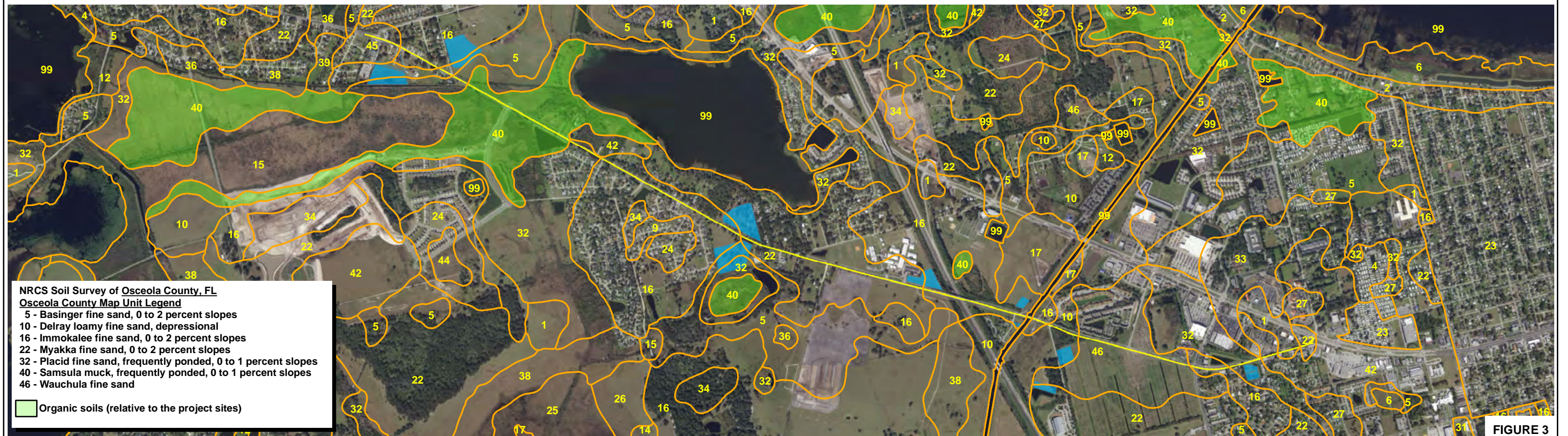
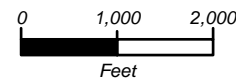
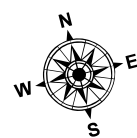

FIGURE 3



**Geotechnical and Environmental Consultants, Inc. (GEC)**  
2510 Michigan Avenue, Suite D  
Kissimmee, FL 34744-1933  
PH (407) 483-1212 FAX (407) 932-2912  
Certificate of Authorization No. 00005882  
GARY L. KUHN'S P.E. NO. 38704



**OSCEOLA COUNTY**  
**ENGINEERING DEPARTMENT**  
1 Court Square, Suite 1100  
Kissimmee, Florida 34741-5488  
(407) 343-2600 Fax: (407) 343-2623

**USGS QUADRANGLE AND  
NRCS SOIL SURVEY MAPS**

SHEET  
NO.

**FIGURES 4A- 4E**  
**BORING AND PROBE LOCATION PLAN**



FIGURE 4A

SURFICIAL MUCK THICKNESS (FT.)   
 STANDING WATER DEPTH (FT.)   
 (8.5/0.0)   
 INACCESSIBLE BORING / PROBE LOCATION   
 AUGER BORING LOCATION   
 MUCK PROBE LOCATION (PERFORMED ON 2-25-19)

**Geotechnical and Environmental Consultants, Inc. (GEC)**  
 2510 Michigan Avenue, Suite D  
 Kissimmee, FL 34744-1933  
 PH (407) 483-1212 FAX (407) 932-2912  
 Certificate of Authorization No. 00005882  
 GARY L. KUHNIS P.E. NO. 38704

**OSCEOLA COUNTY ENGINEERING DEPARTMENT**  
 1 Court Square, Suite 1100  
 Kissimmee, Florida 34741-5488  
 (407) 343-2600 Fax:(407) 343-2623

**BORING AND PROBE LOCATION PLAN**

SHEET NO.

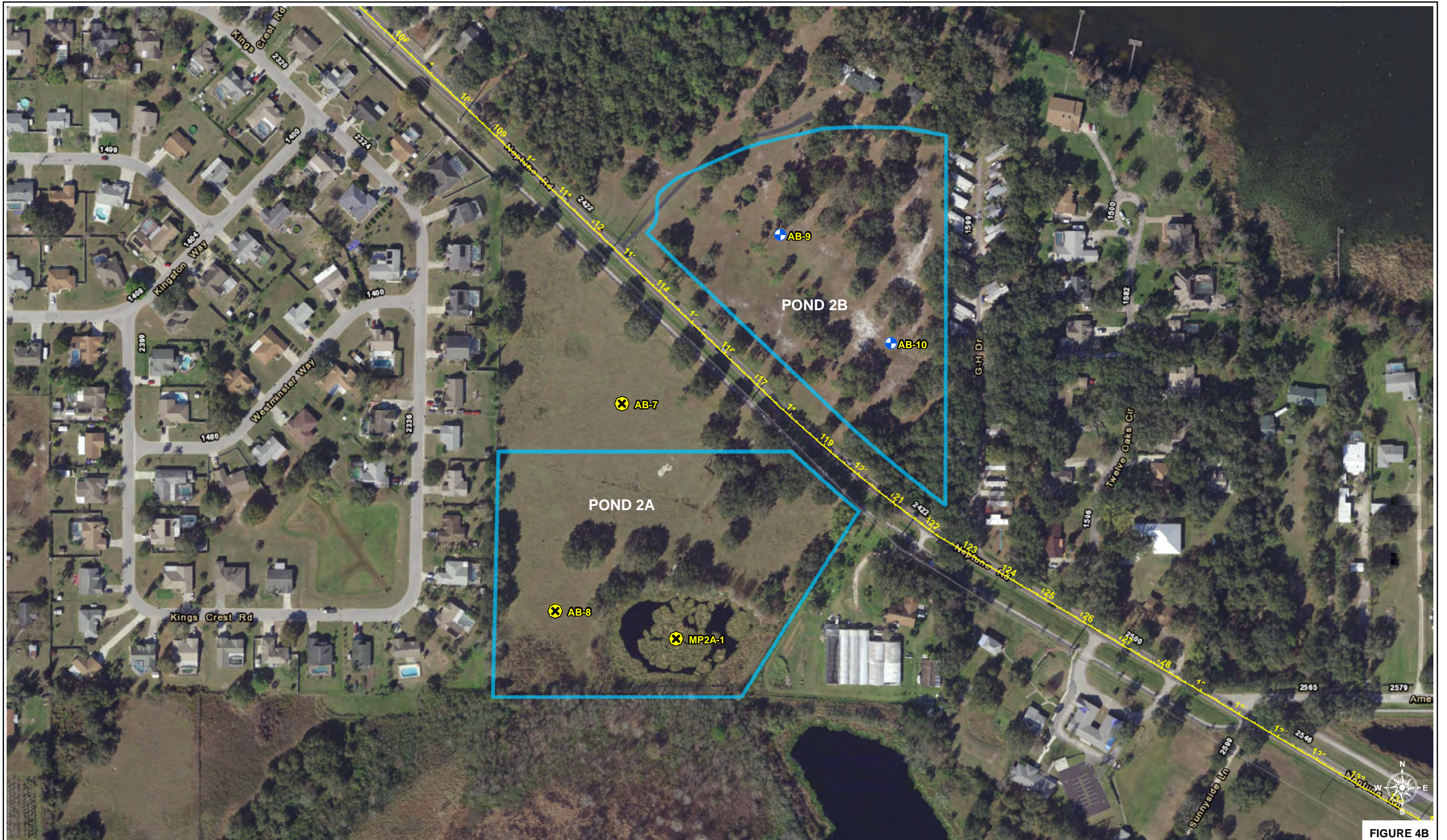





FIGURE 4B

SURFICIAL MUCK THICKNESS (FT.)  INACCESSIBLE BORING / PROBE LOCATION  
 STANDING WATER DEPTH (FT.)  AUGER BORING LOCATION  
 (8.5/0.0) MUCK PROBE LOCATION (PERFORMED ON 2-25-19)

0 100 200  
 Feet

**Geotechnical and Environmental Consultants, Inc. (GEC)**  
 2510 Michigan Avenue, Suite D  
 Kissimmee, FL 34744-1933  
 PH (407) 483-1212 FAX (407) 932-2912  
 Certificate of Authorization No. 00005882  
 GARY L. KUHN'S P.E. NO. 38704







**OSCEOLA COUNTY**  
**ENGINEERING DEPARTMENT**  
 1 Court Square, Suite 1100  
 Kissimmee, Florida 34741-5488  
 (407) 343-2600 Fax: (407) 343-2623

**BORING AND PROBE LOCATION PLAN**

SHEET NO.



FIGURE 4C

SURFICIAL MUCK THICKNESS (FT.)  INACCESSIBLE BORING / PROBE LOCATION  
 STANDING WATER DEPTH (FT.)  AUGER BORING LOCATION  
 MUCK PROBE LOCATION (PERFORMED ON 2-25-19)

0 100 200  
 Feet

**Geotechnical and Environmental Consultants, Inc. (GEC)**  
 2510 Michigan Avenue, Suite D  
 Kissimmee, FL 34744-1933  
 PH (407) 483-1212 FAX (407) 932-2912  
 Certificate of Authorization No. 00005882  
 GARY L. KUHN'S P.E. NO. 38704

**GEC**

**OSCEOLA COUNTY ENGINEERING DEPARTMENT**  
 1 Court Square, Suite 1100  
 Kissimmee, Florida 34741-5488  
 (407) 343-2600 Fax: (407) 343-2623

**BORING AND PROBE LOCATION PLAN**

SHEET NO.



FIGURE 4D

SURFICIAL MUCK THICKNESS (FT.)   
 STANDING WATER DEPTH (FT.)   
 (8.5/0.0)   
 INACCESSIBLE BORING / PROBE LOCATION   
 AUGER BORING LOCATION   
 MUCK PROBE LOCATION (PERFORMED ON 2-25-19)

0 100 200   
 Feet

**Geotechnical and Environmental Consultants, Inc. (GEC)**  
 2510 Michigan Avenue, Suite D  
 Kissimmee, FL 34744-1933  
 PH (407) 483-1212 FAX (407) 932-2912  
 Certificate of Authorization No. 00005882  
 GARY L. KUHN'S P.E. NO. 38704

**GEC**

**OSCEOLA COUNTY ENGINEERING DEPARTMENT**  
 1 Court Square, Suite 1100  
 Kissimmee, Florida 34741-5488  
 (407) 343-2600 Fax:(407) 343-2623

**BORING AND PROBE LOCATION PLAN**

SHEET NO.

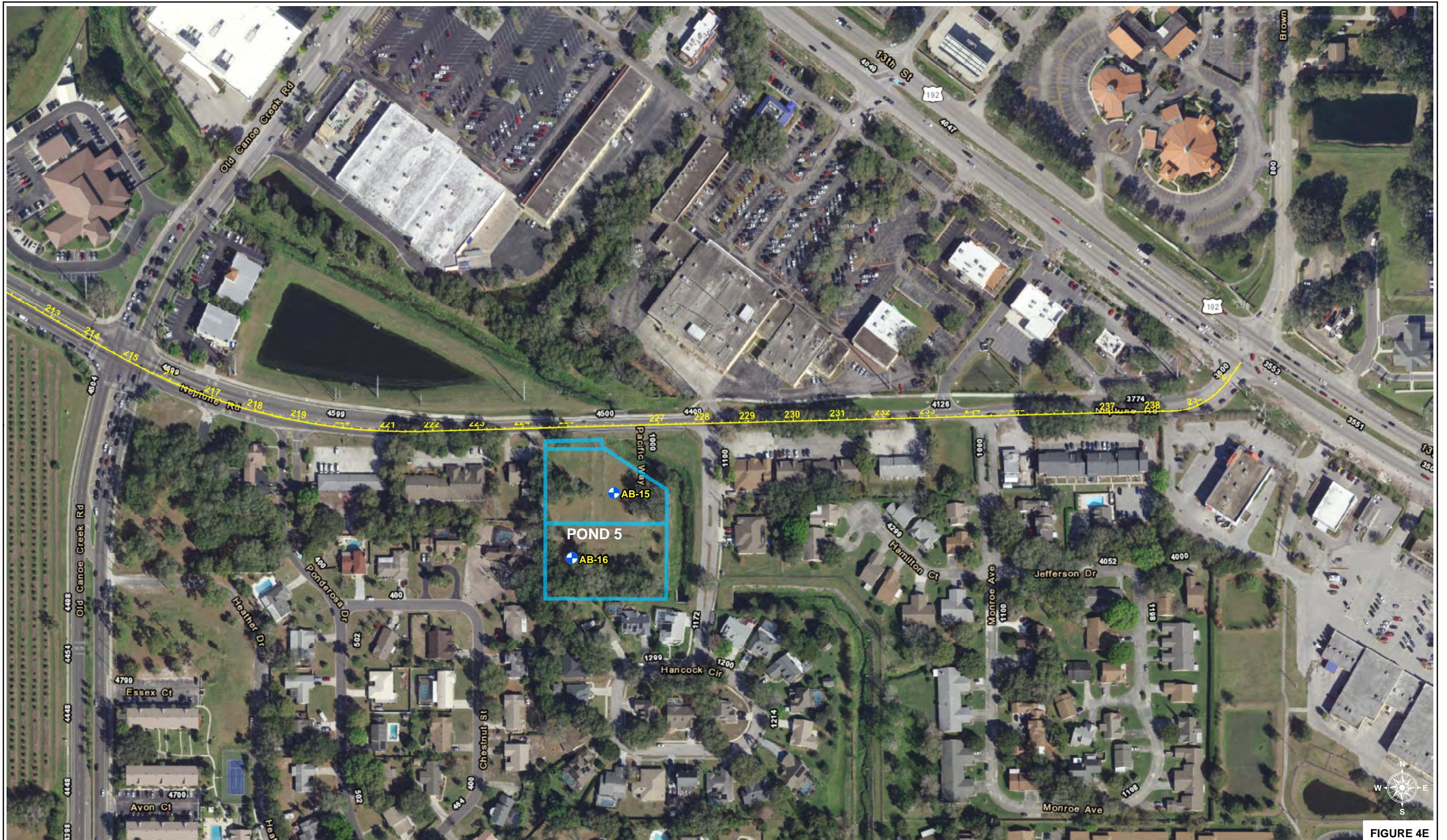





FIGURE 4E

SURFICIAL MUCK THICKNESS (FT.)  INACCESSIBLE BORING / PROBE LOCATION  
 STANDING WATER DEPTH (FT.)  AUGER BORING LOCATION  
 (8.5/0.0) MUCK PROBE LOCATION (PERFORMED ON 2-25-19)

0 100 200  
 Feet

**Geotechnical and Environmental Consultants, Inc. (GEC)**  
 2510 Michigan Avenue, Suite D  
 Kissimmee, FL 34744-1933  
 PH (407) 483-1212 FAX (407) 932-2912  
 Certificate of Authorization No. 00005882  
 GARY L. KUHN'S P.E. NO. 38704



**OSCEOLA COUNTY**  
**ENGINEERING DEPARTMENT**  
 1 Court Square, Suite 1100  
 Kissimmee, Florida 34741-5488  
 (407) 343-2600 Fax: (407) 343-2623

**BORING AND PROBE LOCATION PLAN**

SHEET NO.

**FIGURE 5**  
**ROADWAY SOIL SURVEY**



DATE OF SURVEY: FEBRUARY 2019  
 SURVEY MADE BY: GEOTECHNICAL AND ENVIRONMENTAL CONSULTANTS, INC. (GEC)  
 SUBMITTED BY: GARY L. KUHNS, P.E.

## CROSS SECTION SOIL SURVEY FOR THE DESIGN OF ROADS

CITY: KISSIMMEE  
 ROAD NO.: CR 525  
 COUNTY: OSCEOLA

PROJECT NAME: NEPTUNE ROAD PD&E STUDY

NEPTUNE ROAD APPROXIMATE BEGIN STA. : 30+26    NEPTUNE ROAD APPROXIMATE END STA. : 240+34  
 STATIONS REFERENCE: CENTERLINE OF CONSTRUCTION

STRATUM NO.	ORGANIC CONTENT		MOISTURE CONTENT		SIEVE ANALYSIS RESULTS PERCENT PASS (%)					ATTERBERG LIMITS (%)			DESCRIPTION	CORROSION TEST RESULTS						
	NO. OF TESTS	% ORGANIC	NO. OF TESTS	MOISTURE CONTENT	NO. OF TESTS	10 MESH	40 MESH	60 MESH	100 MESH	200 MESH	NO. OF TESTS	LIQUID LIMIT		PLASTIC INDEX	AASHTO GROUP	NO. OF TESTS	RESISTIVITY ohm-cm	CHLORIDE ppm	SULFATES ppm	pH
1	0	-	0	-	4	94-100	94-100	84-97	45-74	5-9	0	-	-	A-3	LIGHT BROWN TO BROWN TO DARK BROWN TO GRAY TO LIGHT GRAY FINE SAND TO FINE SAND WITH SILT, OCCASIONAL TRACE LIMEROCK AND ASPHALT FRAGMENTS	0	-	-	-	-
2	0	-	0	-	3	98-100	96-100	92-98	63-82	11-19	0	-	-	A-2-4	LIGHT BROWN TO BROWN TO GRAY FINE SAND WITH SILT TO SILTY FINE SAND, OCCASIONAL LIMEROCK FRAGMENTS	0	-	-	-	-
3	0	-	1	19	2	100	100	98	77-83	22-25	1	24	6	A-2-4	BROWN TO LIGHT BROWN TO GRAY SILTY FINE SAND, OCCASIONAL TRACE CLAY	0	-	-	-	-
4	0	-	2	22-27	2	100	99-100	92-99	74-87	39-46	2	36-37	21-22	A-2-6, A-6	BROWN CLAYEY FINE SAND	0	-	-	-	-
5	1	13	1	41	1	100	100	97	77	24	0	-	-	A-8	DARK BROWN MUCKY FINE SAND	0	-	-	-	-

**NOTES**

1. STRATA BOUNDARIES ARE APPROXIMATE AND REPRESENT SOIL STRATA AT EACH TEST HOLE LOCATION ONLY. ANY STRATUM CONNECTING LINES THAT ARE SHOWN ARE FOR ESTIMATING EARTHWORK ONLY AND DO NOT INDICATE ACTUAL STRATUM LIMITS. SUBSURFACE VARIATIONS BETWEEN BORINGS SHOULD BE ANTICIPATED.
2. GROUNDWATER LEVEL SHOWN AS ▼ WHERE ENCOUNTERED AT TIME OF SURVEY. ESTIMATED SEASONAL HIGH GROUNDWATER LEVEL SHOWN AS ▽.
3. REMOVAL OF MUCK AND PLASTIC MATERIAL OCCURRING WITHIN ROADWAY SHALL BE ACCOMPLISHED IN ACCORDANCE WITH THE FDOT STANDARD PLANS, INDEX NO. 120-002 UNLESS OTHERWISE SHOWN ON PLANS. THE MATERIAL USED IN EMBANKMENT CONSTRUCTION SHALL BE IN ACCORDANCE WITH THE FDOT STANDARD PLANS, INDEX NO. 120-001.
4. SOIL ANALYSIS INCLUDES DATA FROM PONDS 1A, 1B, 2B, 2C, 4A AND 5 ONLY.
5. THE SYMBOL "-" REPRESENTS AN UNMEASURED PARAMETER.
6. STRATA 1 AND 2 SHALL BE TREATED AS SELECT (S) MATERIAL IN ACCORDANCE WITH FDOT STANDARD PLANS, INDEX NO. 120-001.
7. STRATA 3 AND 4 SHALL BE TREATED AS PLASTIC (P) MATERIAL IN ACCORDANCE WITH FDOT STANDARD PLANS, INDEX NO. 120-001 AND SHALL BE REMOVED IN ACCORDANCE WITH STANDARD PLANS, INDEX 120-002.
8. STRATUM 5 SHALL BE TREATED AS MUCK (M) MATERIAL IN ACCORDANCE WITH FDOT STANDARD PLANS, INDEX NO. 120-001 AND SHALL BE REMOVED IN ACCORDANCE WITH STANDARD PLANS.
9. STRATUM 2 MAY RETAIN EXCESS MOISTURE AND MAY BE DIFFICULT TO DRY AND COMPACT.

**FIGURE 5**

REVISIONS				GEOTECHNICAL AND ENVIRONMENTAL CONSULTANTS, INC. 2510 Michigan Avenue, Suite D Kissimmee, FL 34744-1933 T 407-483-1212 F 407-932-2912 Certificate of Authorization No. 5882 <b>GARY L. KUHNS P.E. NO. 38704</b>	 OSCEOLA COUNTY ENGINEERING DEPARTMENT 1 Courthouse Square, Suite 1100 Kissimmee, Florida 34741-5488 Voice: (407) 343-2600 Fax (407) 343-2623	ROADWAY SOIL SURVEY	SHEET NO.
DATE	DESCRIPTION	DATE	DESCRIPTION				

**FIGURE 6**  
**POND BORING RESULTS**

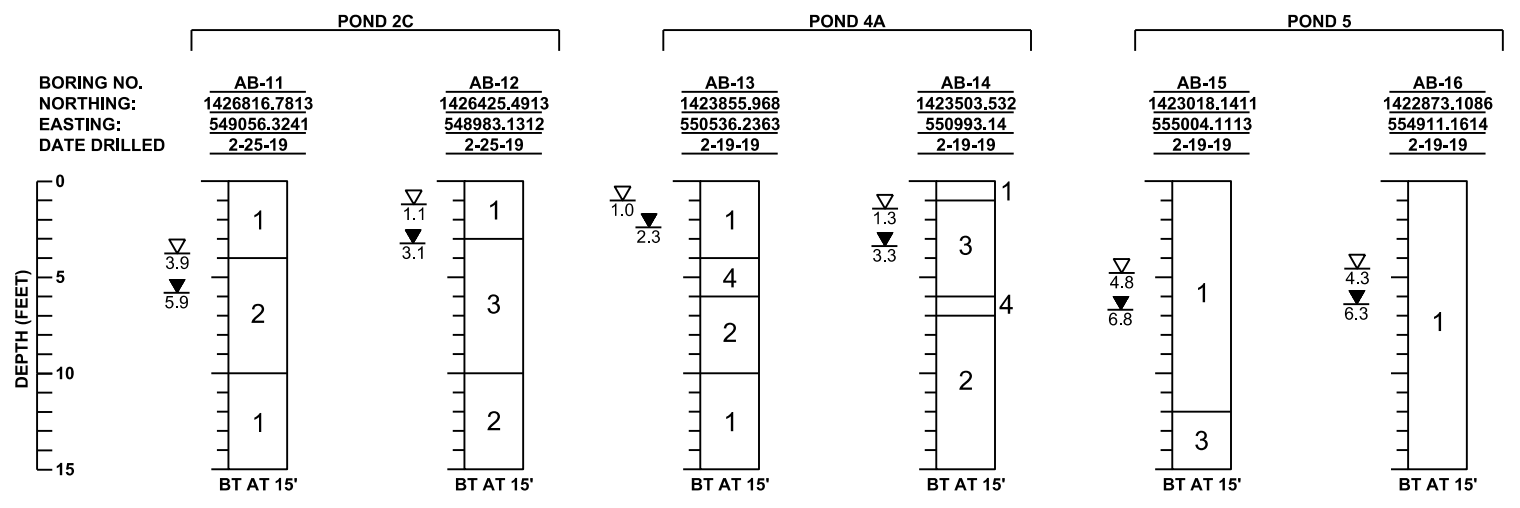
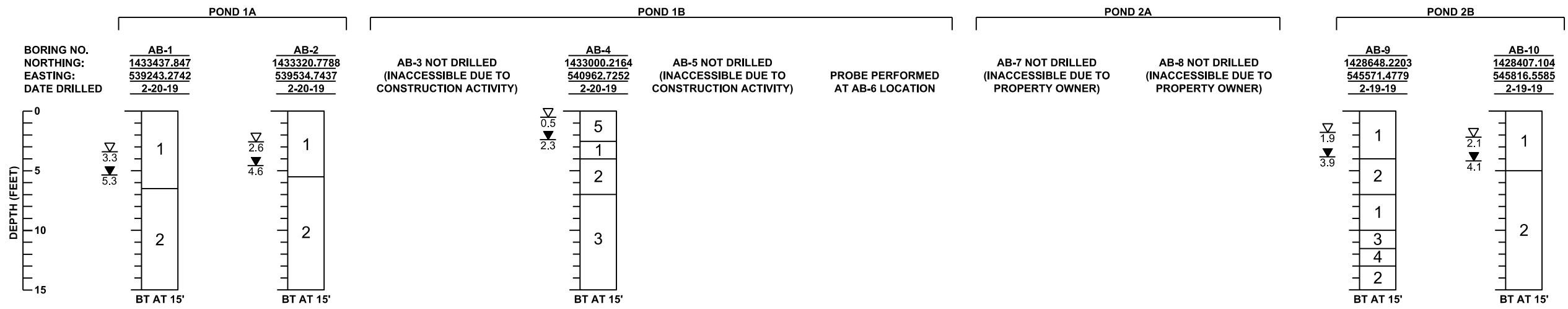

**BORING LEGEND**

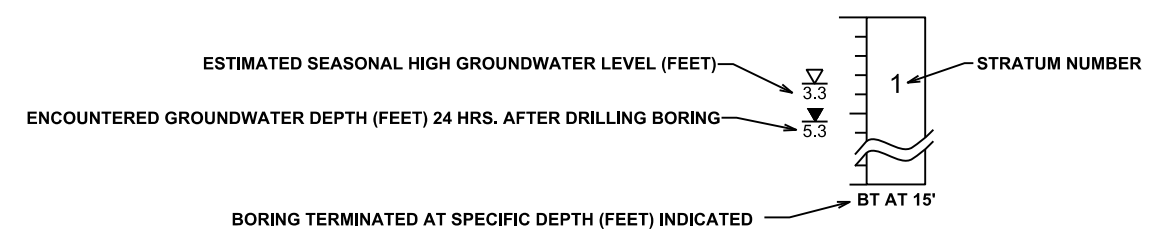

STRATUM NO.	AASHTO CLASSIFICATION	SOIL DESCRIPTION
1	A-3	LIGHT BROWN TO BROWN TO DARK BROWN TO GRAY TO LIGHT GRAY FINE SAND TO FINE SAND WITH SILT, OCCASIONAL TRACE LIMESTONE AND ASPHALT FRAGMENTS
2	A-2-4	LIGHT BROWN TO BROWN TO GRAY FINE SAND WITH SILT TO SILTY FINE SAND, OCCASIONAL LIMESTONE FRAGMENTS
3	A-2-4	BROWN TO LIGHT BROWN TO GRAY SILTY FINE SAND, OCCASIONAL TRACE CLAY
4	A-2-6, A-6	BROWN CLAYEY FINE SAND
5	A-8	DARK BROWN MUCKY FINE SAND

**NOTE**  
STORMWATER POND SITES 3A, 3B AND 4B WERE LATER ADDED AFTER DRILLING OPERATIONS WERE COMPLETE

**FIGURE 6**

REVISIONS				GEOTECHNICAL AND ENVIRONMENTAL CONSULTANTS, INC. 2510 Michigan Avenue, Suite D Kissimmee, FL 34744-1933 T 407-483-1212 F 407-932-2912 Certificate of Authorization No. 5882 <b>GARY L. KUHN'S P.E. NO. 38704</b>	OSCEOLA COUNTY ENGINEERING DEPARTMENT 1 Courthouse Square, Suite 1100 Kissimmee, Florida 34741-5488 Voice: (407) 343-2600 Fax (407) 343-2623	SHEET NO.
DATE	DESCRIPTION	DATE	DESCRIPTION			
					<b>POND BORING RESULTS</b>	

**TABLE 7**  
**SUMMARY OF LABORATORY TEST RESULTS**

**Table 7**  
**Summary of Laboratory Test Results**  
 Neptune Road PD&E Study  
 GEC Project No. 4234G

Stratum No.	Boring No.	Sample Depth (feet)	Percent Passing by Weight					Moisture Content (%)	Atterberg Limits		Organic Content (%)	AASHTO Soil Class.
			#10 Sieve	#40 Sieve	#60 Sieve	#100 Sieve	#200 Sieve		Liquid Limit	Plasticity Index		
1	AB-2	2 - 5.5	94	91	84	45	8	---	---	---	---	<sup>1</sup> A-3
1	AB-10	1.5 - 3	100	99	93	67	5	---	---	---	---	A-3
1	AB-11	0 - 4	100	100	97	74	9	---	---	---	---	A-3
1	AB-16	5 - 10	100	100	97	69	9	---	---	---	---	A-3
2	AB-1	6.5 - 10	100	100	98	82	19	---	---	---	---	A-2-4
2	AB-9	5 - 7	100	99	93	67	15	---	---	---	---	A-2-4
2	AB-15	0 - 4	98	96	92	63	11	---	---	---	---	<sup>2</sup> A-2-4
3	AB-12	5.5 - 10	100	100	98	77	22	---	---	---	---	A-2-4
3	AB-14	1 - 4	100	100	98	83	25	19	24	6	---	A-2-4
4	AB-9	11.5 - 13	100	99	92	74	46	27	37	22	---	A-6
4	AB-13	4 - 6	100	100	99	87	39	22	36	21	---	A-6
5	AB-4	0 - 2.5	100	100	97	77	24	41	---	---	13	A-8

**Notes:**

- 1: Trace Limerock and Asphalt Fragments
- 2: Some Limerock

**2009 ROADWAY SOIL SURVEY  
ROADWAY AND POND BORING RESULTS**

# **ROADWAY AUGER BORING RESULTS**

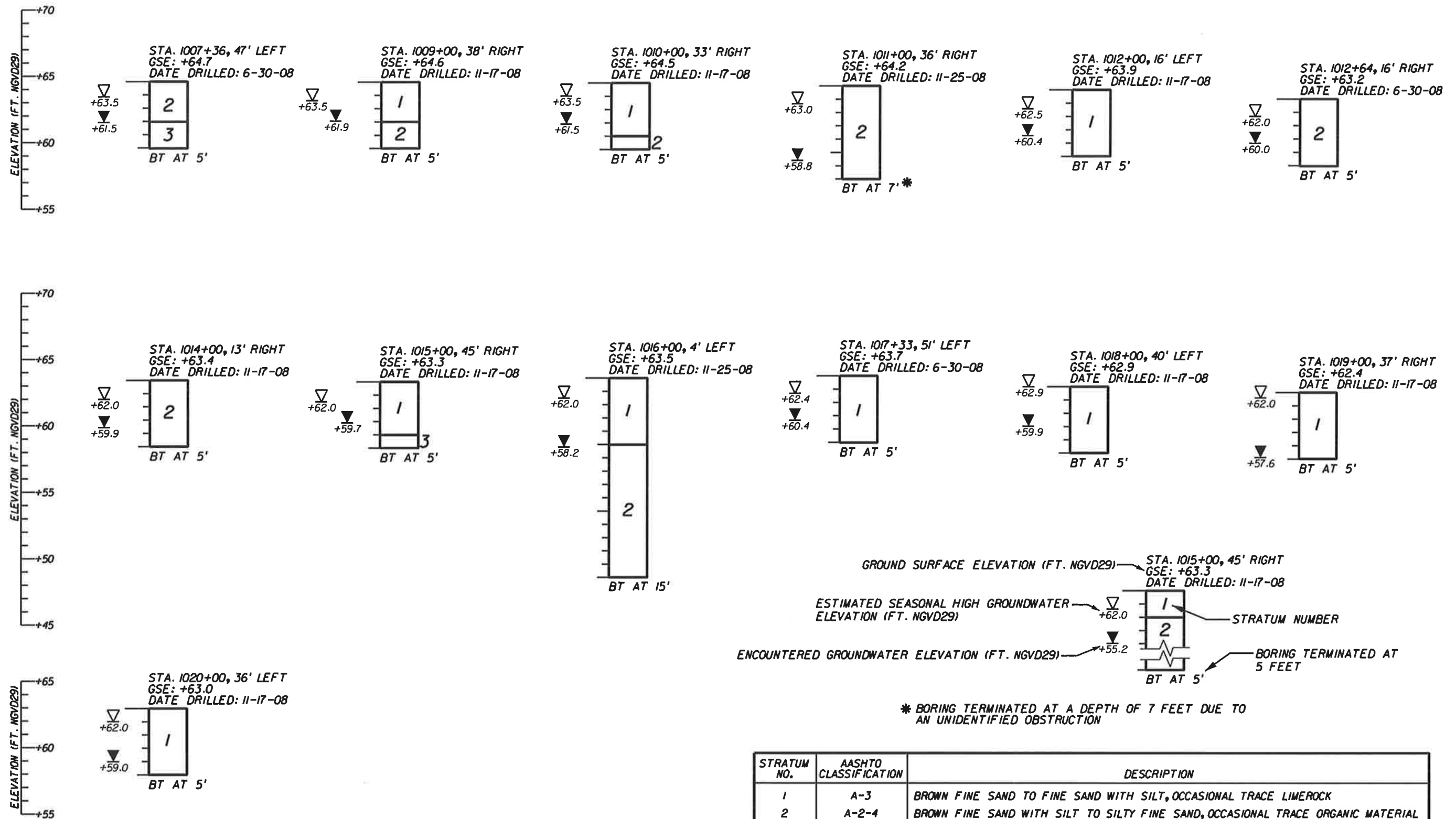

STRATUM NO.	AASHTO CLASSIFICATION	DESCRIPTION
1	A-3	BROWN FINE SAND TO FINE SAND WITH SILT, OCCASIONAL TRACE LIMEROCK
2	A-2-4	BROWN FINE SAND WITH SILT TO SILTY FINE SAND, OCCASIONAL TRACE ORGANIC MATERIAL
3	A-2-6, A-4, A-6	LIGHT BROWN CLAYEY FINE SAND, SANDY SILT AND SANDY CLAY

FIGURE 3

REVISIONS				Michael W. Byerly, P.E. P.E. License No. 52586 Geotechnical and Environmental Consultants, Inc. 2510 Michigan Avenue, Suite D Kissimmee, FL 34744-1933 PH (407) 483-1212 FAX (407) 932-2912 Certificate of Authorization No. 00005882	OSCEOLA COUNTY CIP PROJECT NO. 4331/4334			<b>AUGER BORING RESULTS</b>	SHEET NO.
DATE	DESCRIPTION	DATE	DESCRIPTION		COUNTY ROAD NO.	COUNTY	FINANCIAL PROJECT ID		
					525	OSCEOLA			

NOTICE: THE OFFICIAL RECORD OF THIS SHEET IS THE ELECTRONIC FILE SIGNED AND SEALED UNDER RULE 68J5-23.003, F.A.C.



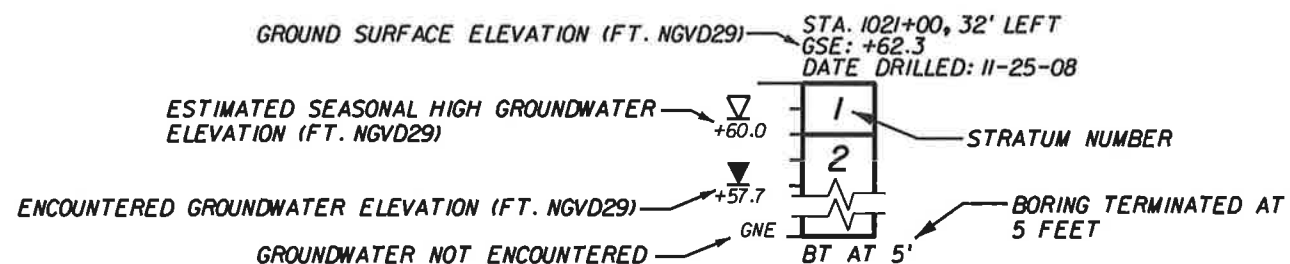
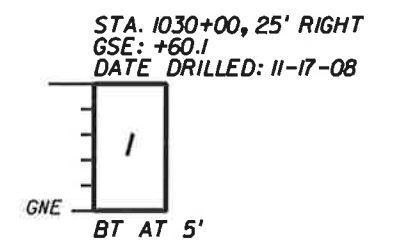
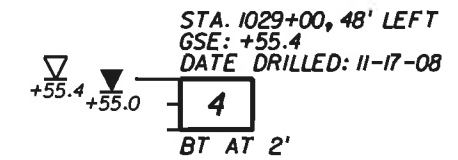
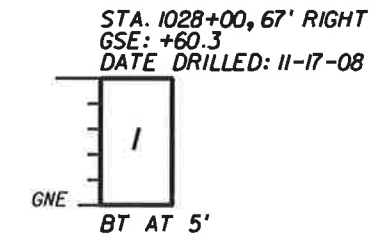
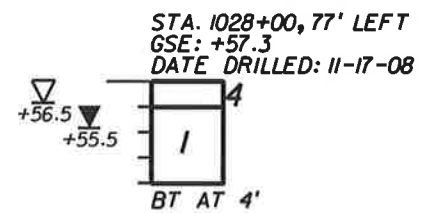
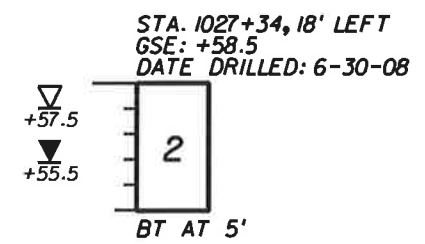
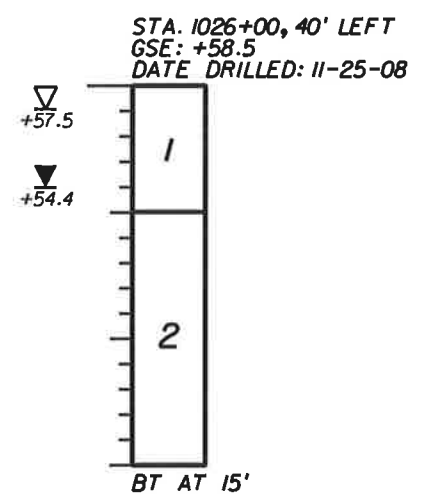
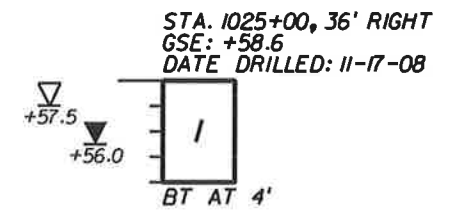
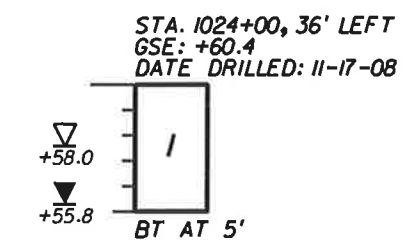
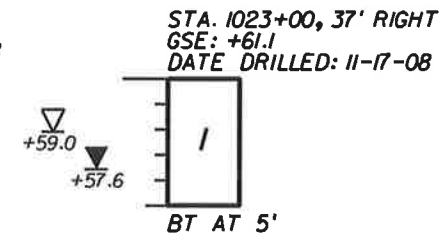
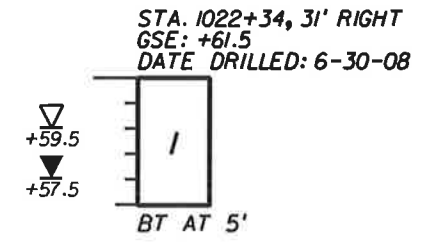
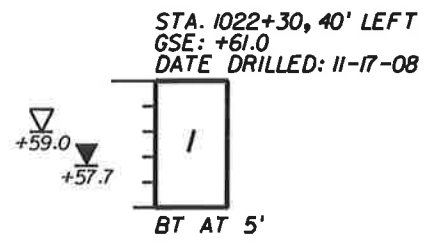
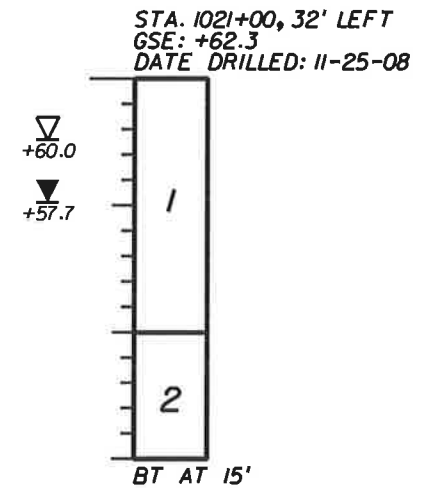

STRATUM NO.	AASHTO CLASSIFICATION	DESCRIPTION
1	A-3	BROWN FINE SAND TO FINE SAND WITH SILT, OCCASIONAL TRACE LIMEROCK
2	A-2-4	BROWN FINE SAND WITH SILT TO SILTY FINE SAND, OCCASIONAL TRACE ORGANIC MATERIAL
4	A-8	DARK BROWN MUCKY FINE SAND, SANDY MUCK AND MUCK

FIGURE 4

REVISIONS				Michael W. Byerly, P.E. P.E. License No. 52586 Geotechnical and Environmental Consultants, Inc. 2510 Michigan Avenue, Suite D Kissimmee, FL 34744-1933 PH (407) 483-1212 FAX (407) 932-2912 Certificate of Authorization No. 00005882	OSCEOLA COUNTY CIP PROJECT NO. 4331/4334			<b>AUGER BORING RESULTS</b>	SHEET NO.
DATE	DESCRIPTION	DATE	DESCRIPTION		COUNTY ROAD NO.	COUNTY	FINANCIAL PROJECT ID		
					525	OSCEOLA			

NOTICE: THE OFFICIAL RECORD OF THIS SHEET IS THE ELECTRONIC FILE SIGNED AND SEALED UNDER RULE 68G5-23.003, F.A.C.

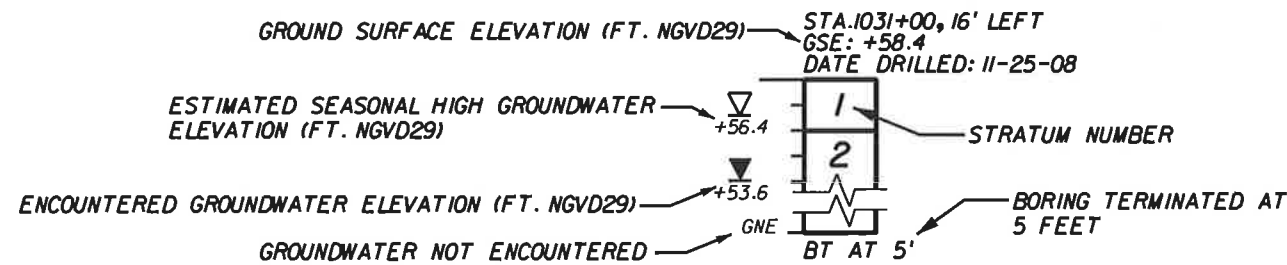
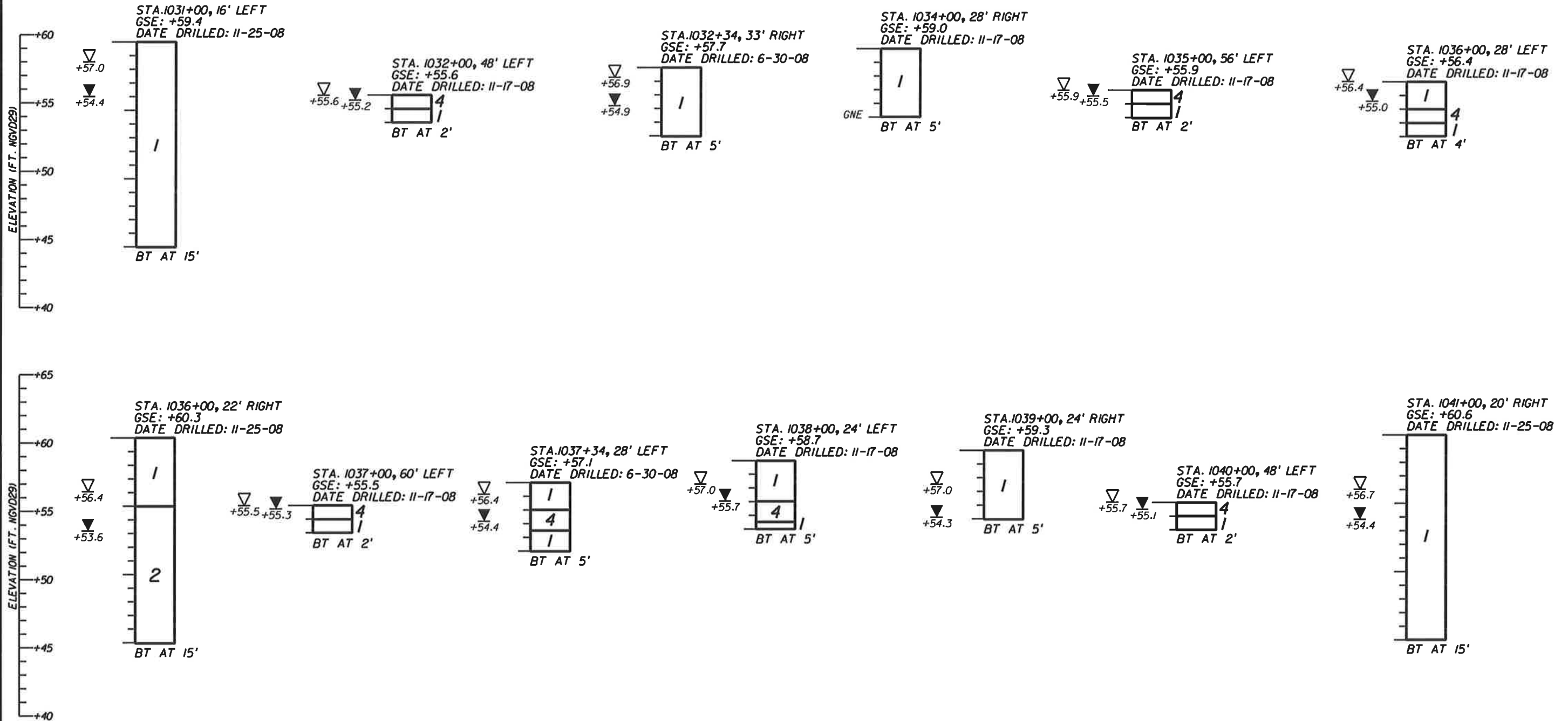

STRATUM NO.	AASHTO CLASSIFICATION	DESCRIPTION
1	A-3	BROWN FINE SAND TO FINE SAND WITH SILT, OCCASIONAL TRACE LIMEROCK
2	A-2-4	BROWN FINE SAND WITH SILT TO SILTY FINE SAND, OCCASIONAL TRACE ORGANIC MATERIAL
4	A-8	DARK BROWN MUCKY FINE SAND, SANDY MUCK AND MUCK

FIGURE 5

REVISIONS				Michael W. Beyerly, P.E. P.E. License No. 52586 Geotechnical and Environmental Consultants, Inc. 2510 Michigan Avenue, Suite D Kissimmee, FL 34744-1933 PH (407) 483-1212 FAX (407) 932-2912 Certificate of Authorization No. 00005882	OSCEOLA COUNTY CIP PROJECT NO. 4331/4334			<b>AUGER BORING RESULTS</b>	SHEET NO.
DATE	DESCRIPTION	DATE	DESCRIPTION		COUNTY ROAD NO.	COUNTY	FINANCIAL PROJECT ID		
					525	OSCEOLA			

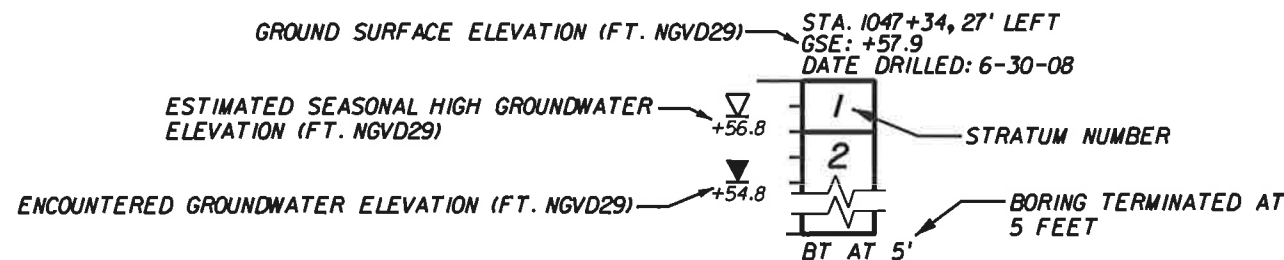
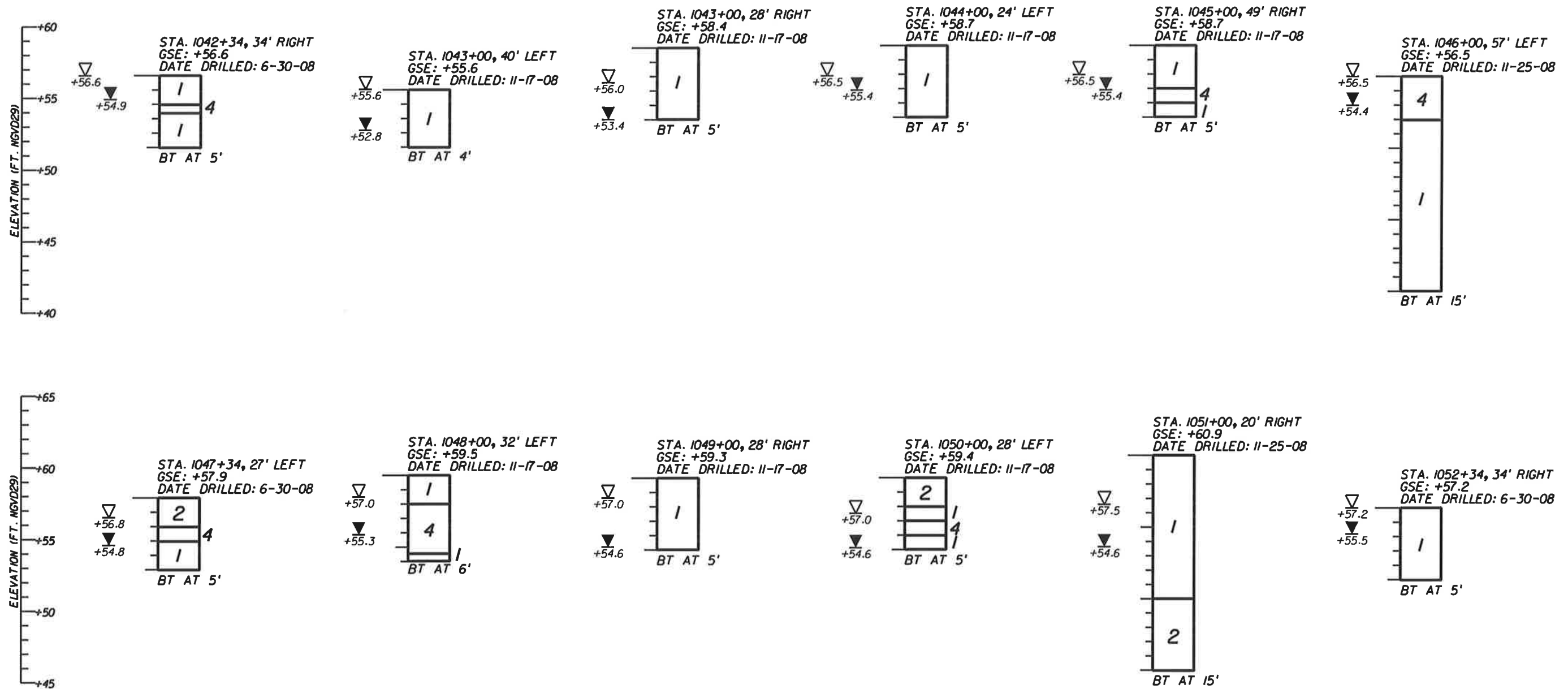

STRATUM NO.	AASHTO CLASSIFICATION	DESCRIPTION
1	A-3	BROWN FINE SAND TO FINE SAND WITH SILT, OCCASIONAL TRACE LIMESTONE
2	A-2-4	BROWN FINE SAND WITH SILT TO SILTY FINE SAND, OCCASIONAL TRACE ORGANIC MATERIAL
4	A-8	DARK BROWN MUCKY FINE SAND, SANDY MUCK AND MUCK

FIGURE 6

REVISIONS				Michael W. Beyerly, P.E. P.E. License No. 52586 Geotechnical and Environmental Consultants, Inc. 2510 Michigan Avenue, Suite D Kissimmee, FL 34744-1933 PH (407) 483-1212 FAX (407) 932-2912 Certificate of Authorization No. 00005882	OSCEOLA COUNTY CIP PROJECT NO. 4331/4334			<b>AUGER BORING RESULTS</b>	SHEET NO.
DATE	DESCRIPTION	DATE	DESCRIPTION		COUNTY ROAD NO.	COUNTY	FINANCIAL PROJECT ID		
					525	OSCEOLA			

NOTICE: THE OFFICIAL RECORD OF THIS SHEET IS THE ELECTRONIC FILE SIGNED AND SEALED UNDER RULE 68G15-23.003, F.A.C.

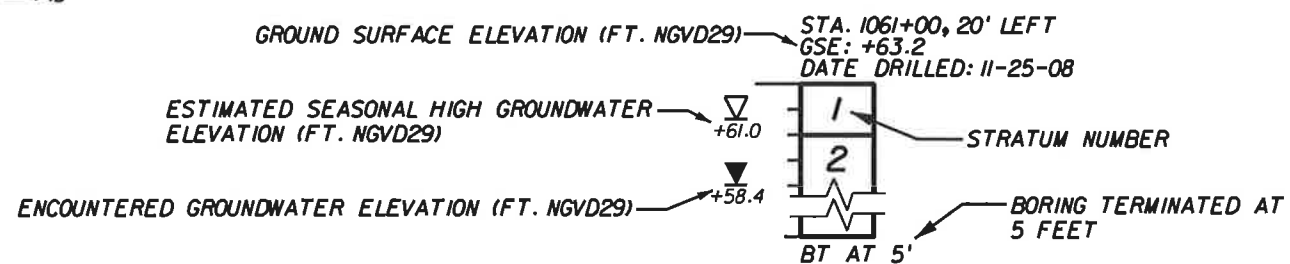
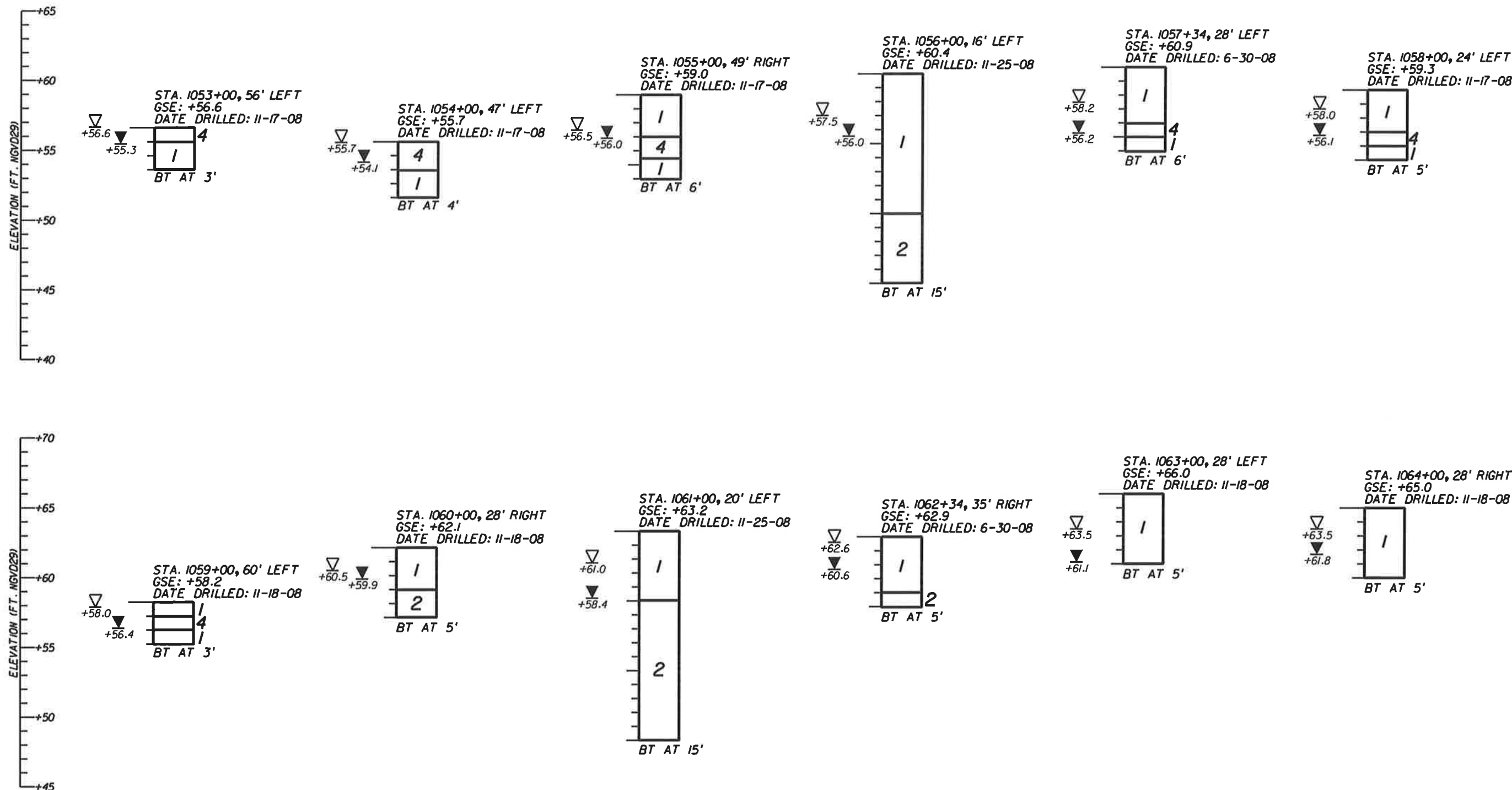

STRATUM NO.	AASHTO CLASSIFICATION	DESCRIPTION
1	A-3	BROWN FINE SAND TO FINE SAND WITH SILT, OCCASIONAL TRACE LIMEROCK
2	A-2-4	BROWN FINE SAND WITH SILT TO SILTY FINE SAND, OCCASIONAL TRACE ORGANIC MATERIAL
4	A-8	DARK BROWN MUCKY FINE SAND, SANDY MUCK AND MUCK

FIGURE 7

REVISIONS				Michael W. Dyerly, P.E. P.E. License No. 52586 Geotechnical and Environmental Consultants, Inc. 2500 Michigan Avenue, Suite D Kissimmee, FL 34744-1933 PH (407) 483-1212 FAX (407) 932-2912 Certificate of Authorization No. 00005882	OSCEOLA COUNTY CIP PROJECT NO. 4331/4334			<b>AUGER BORING RESULTS</b>	SHEET NO.
DATE	DESCRIPTION	DATE	DESCRIPTION		COUNTY ROAD NO.	COUNTY	FINANCIAL PROJECT ID		
					525	OSCEOLA			

NOTICE: THE OFFICIAL RECORD OF THIS SHEET IS THE ELECTRONIC FILE SIGNED AND SEALED UNDER RULE 61G15-23.003, F.A.C.

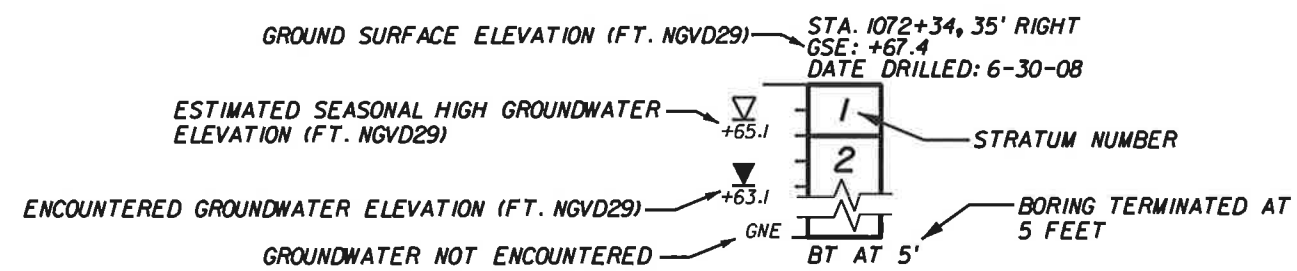
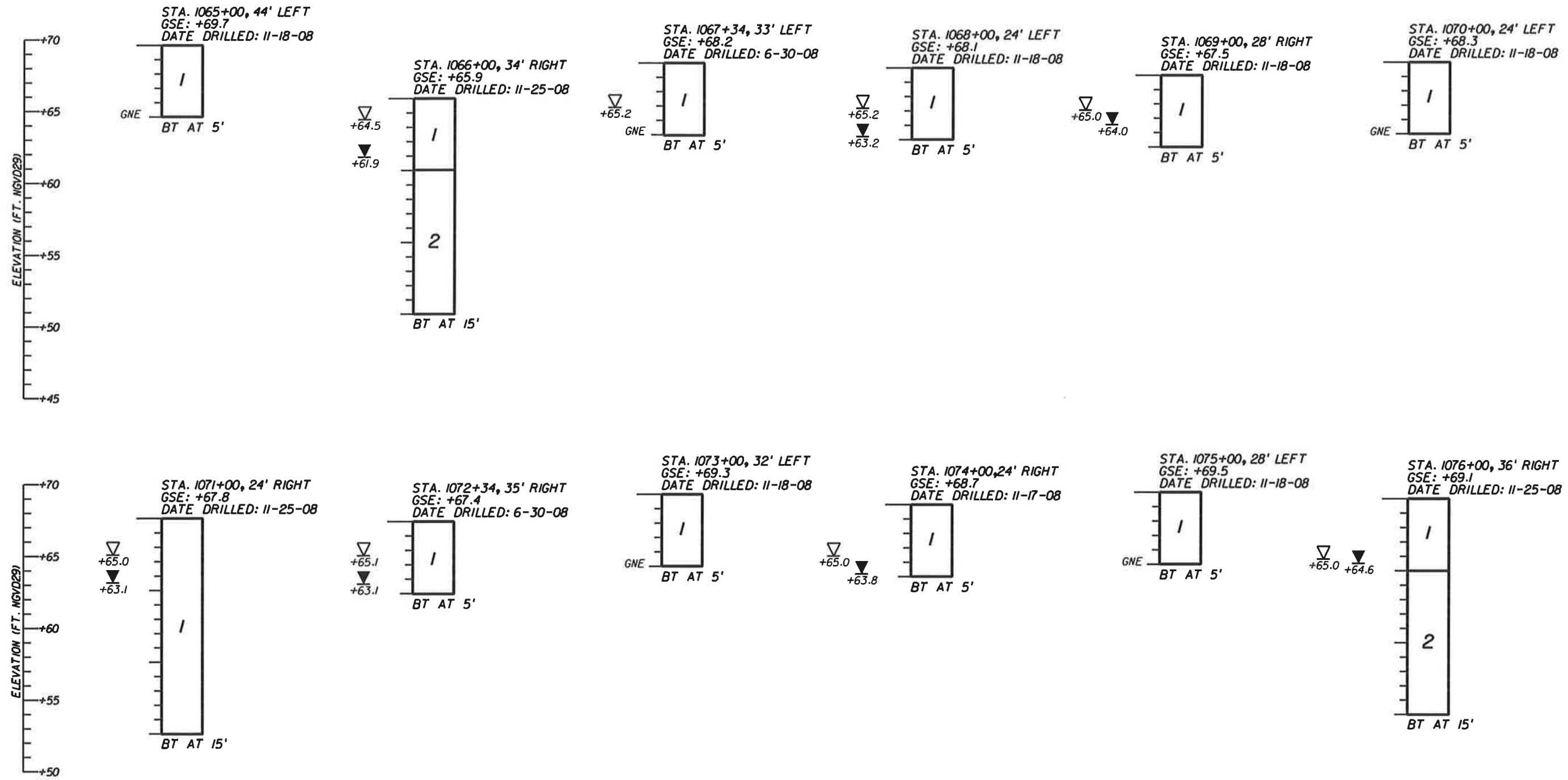
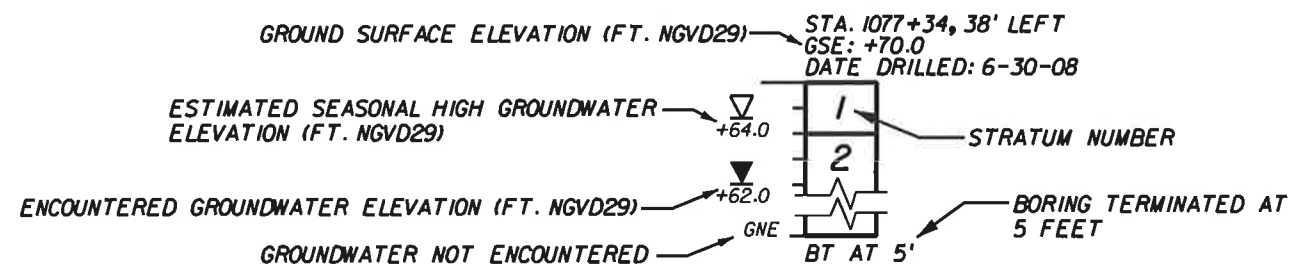
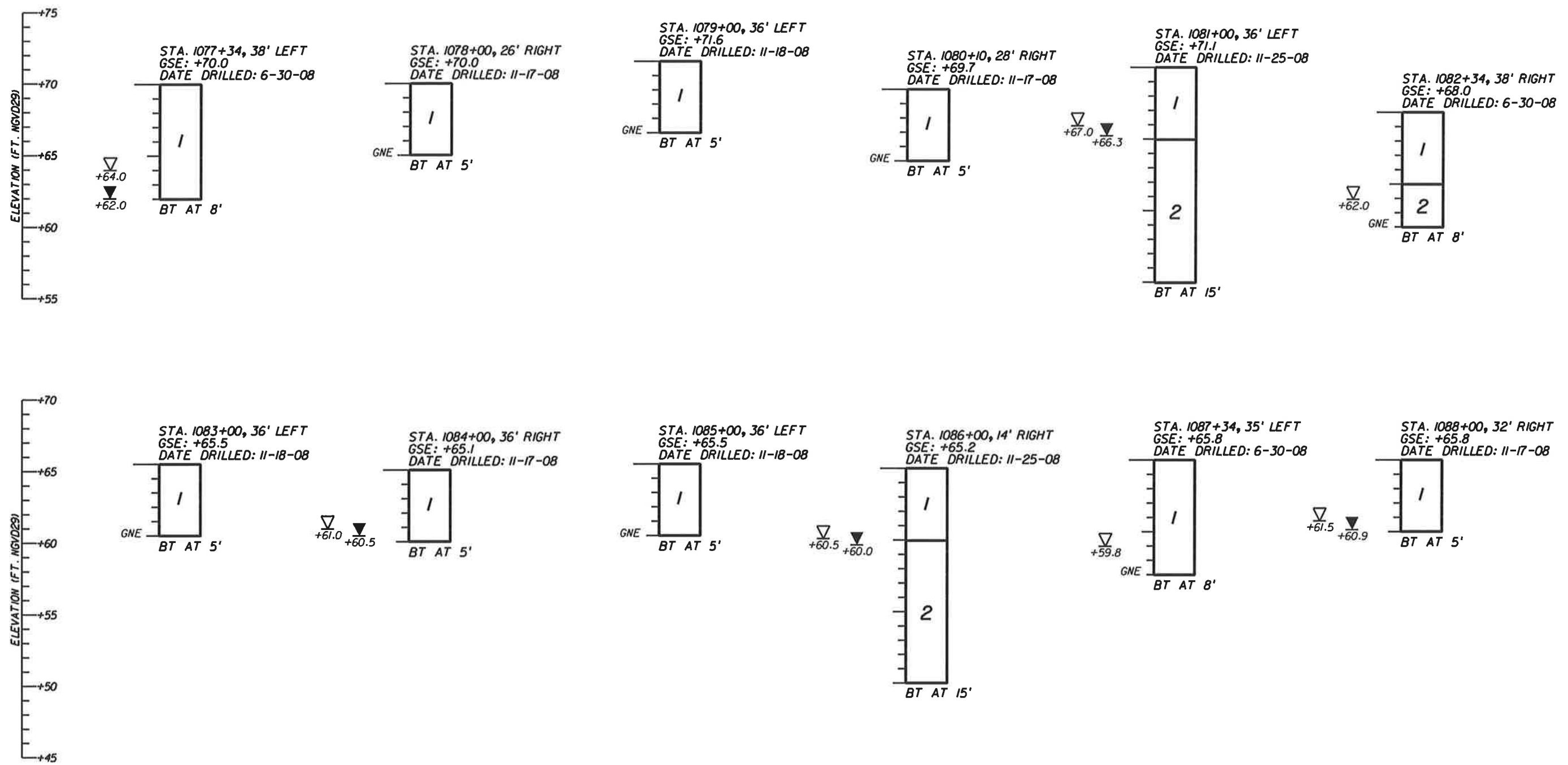

FIGURE 8

REVISIONS				Michael W. Beyerly, P.E. P.E. License No. 52586 Geotechnical and Environmental Consultants, Inc. 2500 Michigan Avenue, Suite D Kissimmee, FL 34744-1933 PH (407) 483-1212 FAX (407) 932-2912 Certificate of Authorization No. 00005882	OSCEOLA COUNTY CIP PROJECT NO. 4331/4334			<b>AUGER BORING RESULTS</b>	SHEET NO.
DATE	DESCRIPTION	DATE	DESCRIPTION		COUNTY ROAD NO.	COUNTY	FINANCIAL PROJECT ID		
					525	OSCEOLA			

NOTICE: THE OFFICIAL RECORD OF THIS SHEET IS THE ELECTRONIC FILE SIGNED AND SEALED UNDER RULE 61G15-23.003, F.A.C.



STRATUM NO.	AASHTO CLASSIFICATION	DESCRIPTION
1	A-3	BROWN FINE SAND TO FINE SAND WITH SILT, OCCASIONAL TRACE LIMEROCK
2	A-2-4	BROWN FINE SAND WITH SILT TO SILTY FINE SAND, OCCASIONAL TRACE ORGANIC MATERIAL

FIGURE 9

REVISIONS				Michael W. Byerly, P.E. P.E. License No. 52596 Geotechnical and Environmental Consultants, Inc. 2510 Michigan Avenue, Suite D Kissimmee, FL 34744-1933 PH (407) 483-1212 FAX (407) 932-2912 Certificate of Authorization No. 00005882	OSCEOLA COUNTY CIP PROJECT NO. 4331/4334			<b>AUGER BORING RESULTS</b>	SHEET NO.
DATE	DESCRIPTION	DATE	DESCRIPTION		COUNTY ROAD NO.	COUNTY	FINANCIAL PROJECT ID		
					525	OSCEOLA			

NOTICE: THE OFFICIAL RECORD OF THIS SHEET IS THE ELECTRONIC FILE SIGNED AND SEALED UNDER RULE 66G5-23.003, F.A.C.

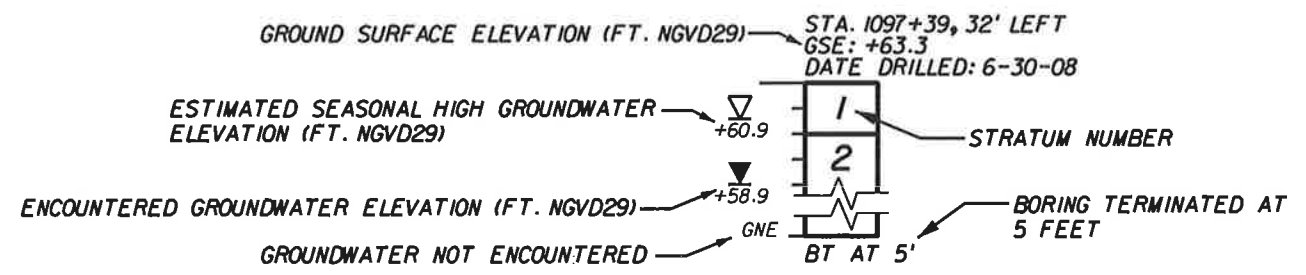
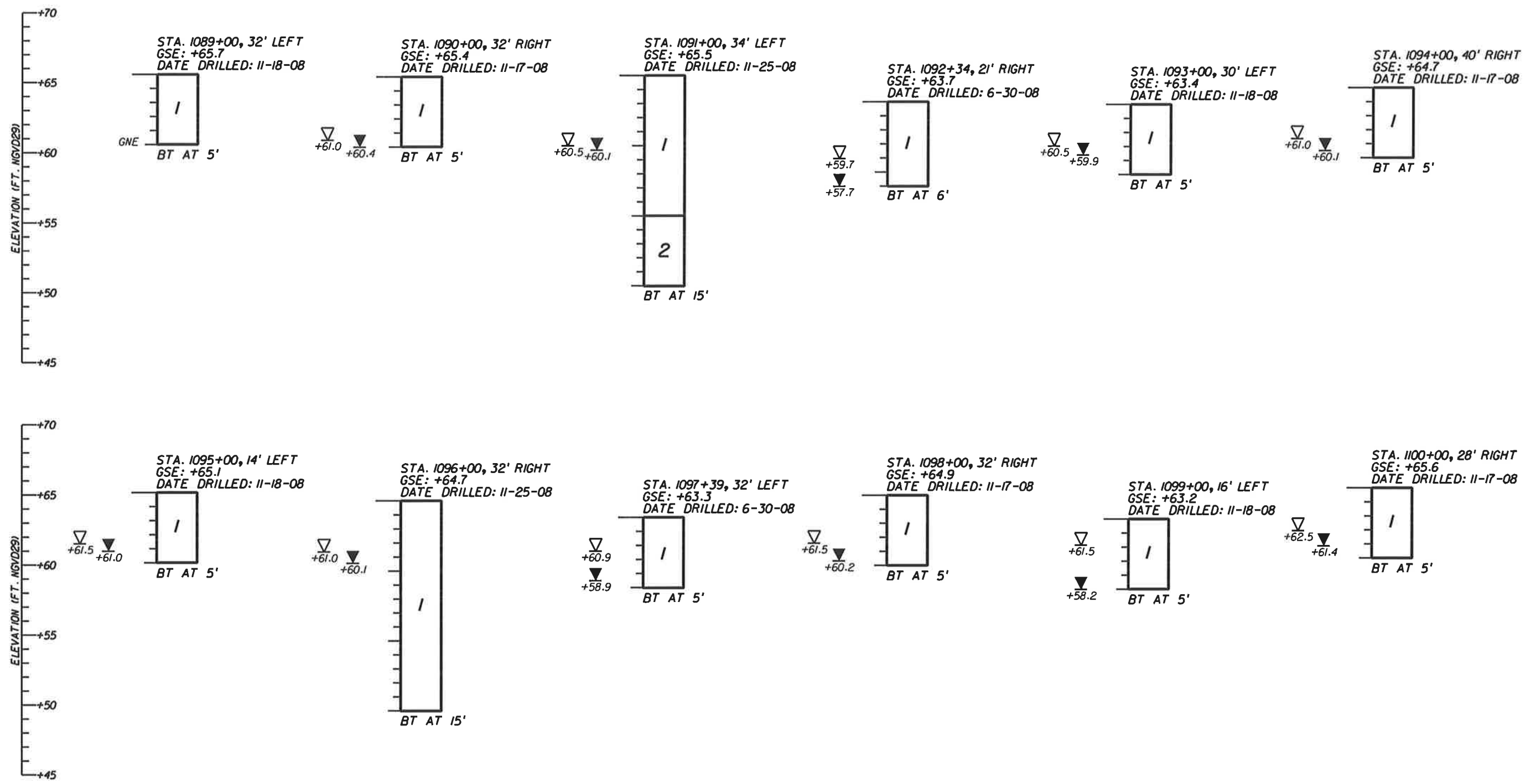

STRATUM NO.	AASHTO CLASSIFICATION	DESCRIPTION
1	A-3	BROWN FINE SAND TO FINE SAND WITH SILT, OCCASIONAL TRACE LIMEROCK
2	A-2-4	BROWN FINE SAND WITH SILT TO SILTY FINE SAND, OCCASIONAL TRACE ORGANIC MATERIAL

FIGURE 10

REVISIONS				Michael W. Byerly, P.E. P.E. License No. 52586 Geotechnical and Environmental Consultants, Inc. 2510 Michigan Avenue, Suite D Kissimmee, FL 34744-1933 PH (407) 483-1212 FAX (407) 932-2912 Certificate of Authorization No. 00005882	OSCEOLA COUNTY CIP PROJECT NO. 4331/4334			<b>AUGER BORING RESULTS</b>	SHEET NO.
DATE	DESCRIPTION	DATE	DESCRIPTION		COUNTY ROAD NO.	COUNTY	FINANCIAL PROJECT ID		
					525	OSCEOLA			

NOTICE: THE OFFICIAL RECORD OF THIS SHEET IS THE ELECTRONIC FILE SIGNED AND SEALED UNDER RULE 61G15-23.003, F.A.C.

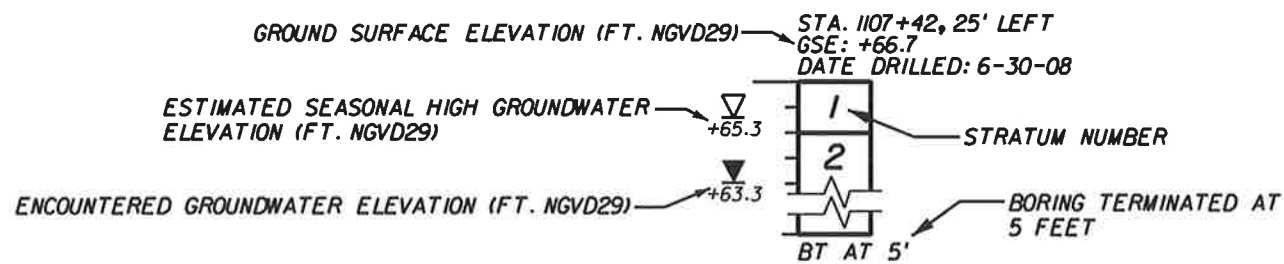
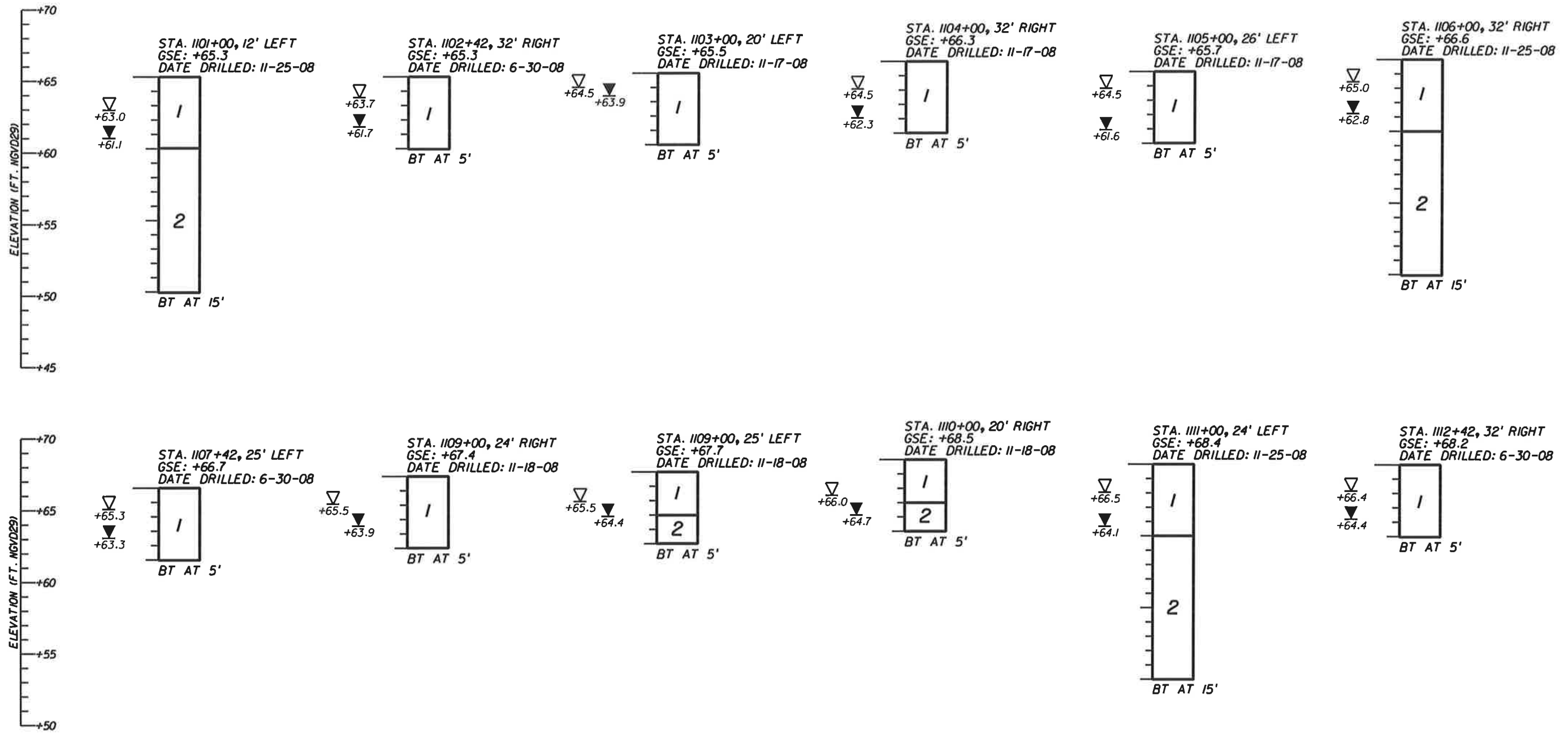

STRATUM NO.	AASHTO CLASSIFICATION	DESCRIPTION
1	A-3	BROWN FINE SAND TO FINE SAND WITH SILT, OCCASIONAL TRACE LIMEROCK
2	A-2-4	BROWN FINE SAND WITH SILT TO SILTY FINE SAND, OCCASIONAL TRACE ORGANIC MATERIAL

FIGURE II

REVISIONS				Michael W. Byerly, P.E. P.E. License No. 52586 Geotechnical and Environmental Consultants, Inc. 2510 Michigan Avenue, Suite D Kissimmee, FL 34744-1933 PH (407) 483-1212 FAX (407) 932-2912 Certificate of Authorization No. 00005882	OSCEOLA COUNTY CIP PROJECT NO. 4331/4334			<b>AUGER BORING RESULTS</b>	SHEET NO.
DATE	DESCRIPTION	DATE	DESCRIPTION		COUNTY ROAD NO.	COUNTY	FINANCIAL PROJECT ID		
					525	OSCEOLA			

NOTICE: THE OFFICIAL RECORD OF THIS SHEET IS THE ELECTRONIC FILE SIGNED AND SEALED UNDER RULE 68G15-23.003, F.A.C.



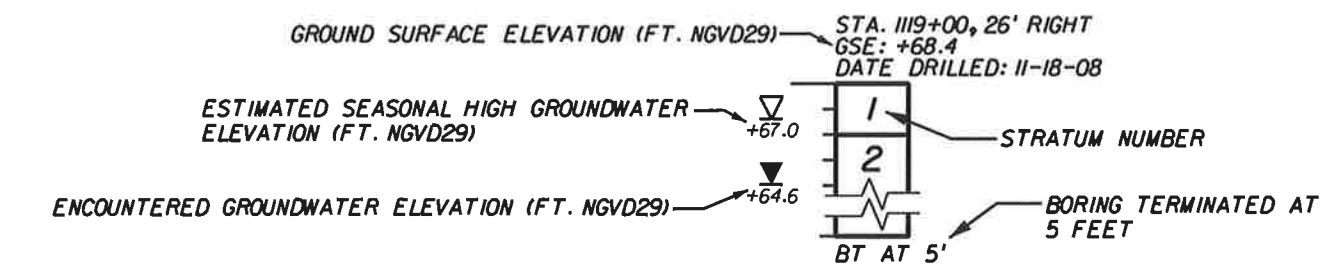
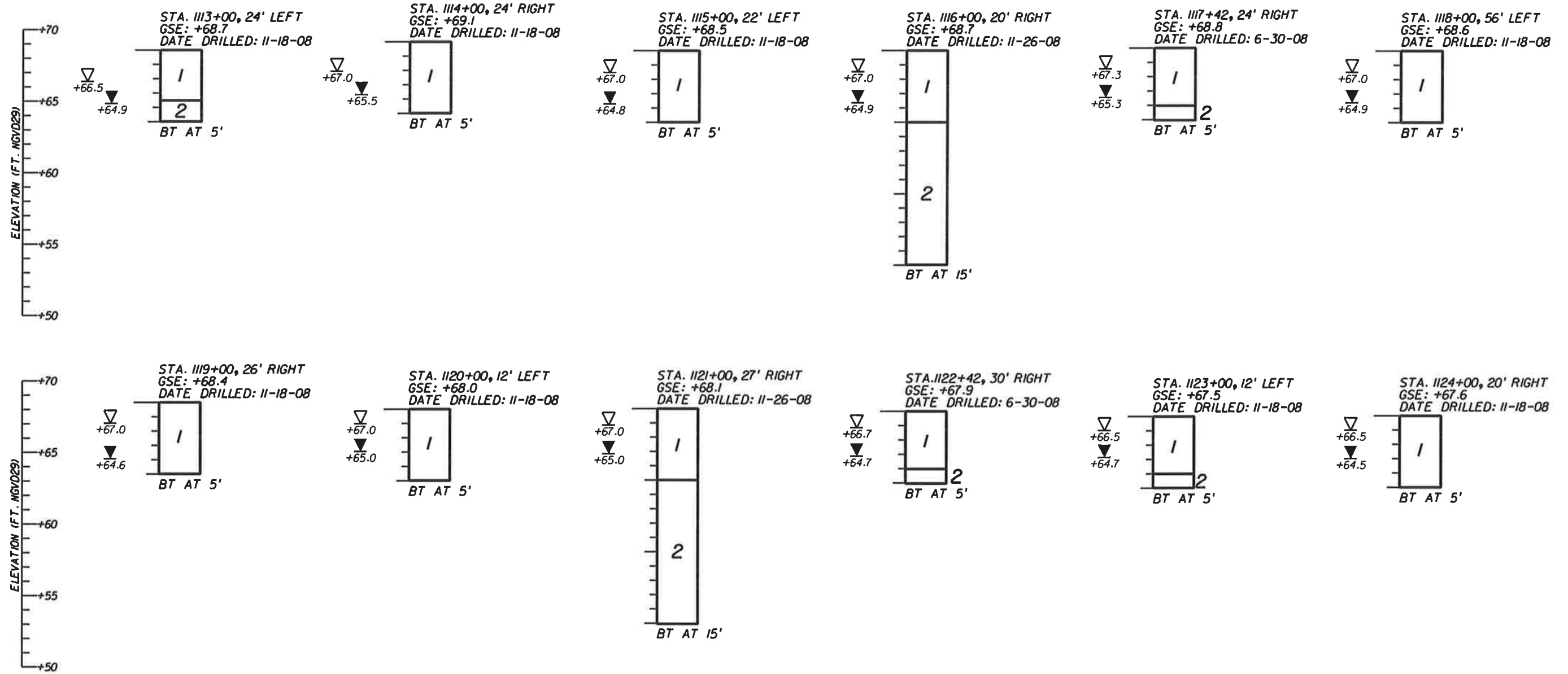

STRATUM NO.	AASHTO CLASSIFICATION	DESCRIPTION
1	A-3	BROWN FINE SAND TO FINE SAND WITH SILT, OCCASIONAL TRACE LIMEROCK
2	A-2-4	BROWN FINE SAND WITH SILT TO SILTY FINE SAND, OCCASIONAL TRACE ORGANIC MATERIAL

FIGURE 12

REVISIONS				Michael W. Byerly, P.E. P.E. License No. 52586 Geotechnical and Environmental Consultants, Inc. 2510 Michigan Avenue, Suite D Kissimmee, FL 34744-1933 PH (407) 483-1212 FAX (407) 932-2912 Certificate of Authorization No. 00005882	OSCEOLA COUNTY CIP PROJECT NO. 4331/434			<b>AUGER BORING RESULTS</b>	SHEET NO.
DATE	DESCRIPTION	DATE	DESCRIPTION		COUNTY ROAD NO.	COUNTY	FINANCIAL PROJECT ID		
					525	OSCEOLA			

NOTICE: THE OFFICIAL RECORD OF THIS SHEET IS THE ELECTRONIC FILE SIGNED AND SEALED UNDER RULE 68G15-23.003, F.A.C.

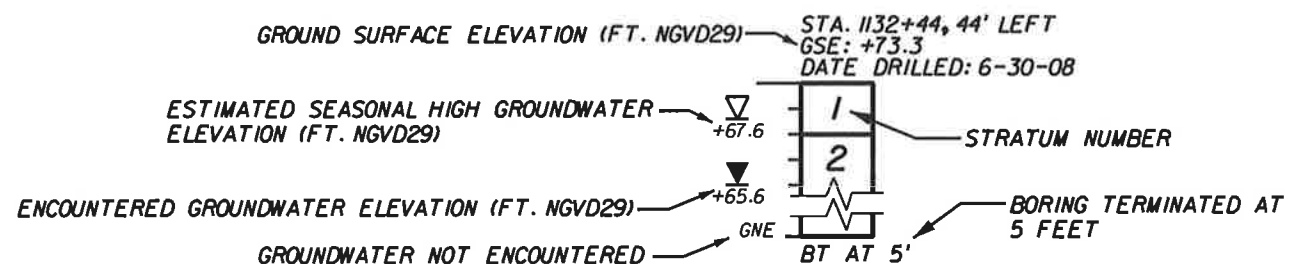
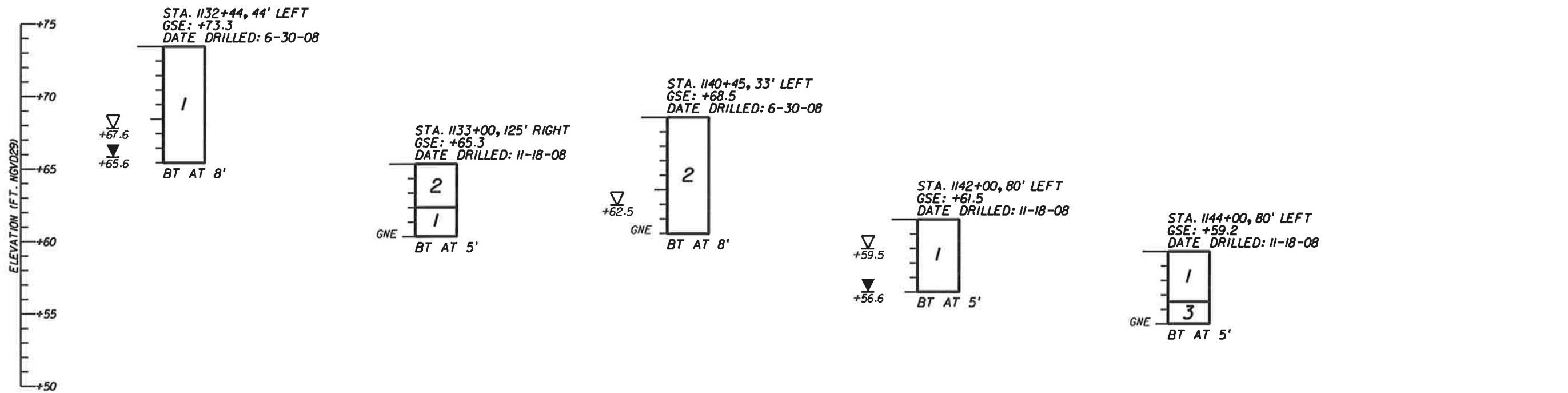
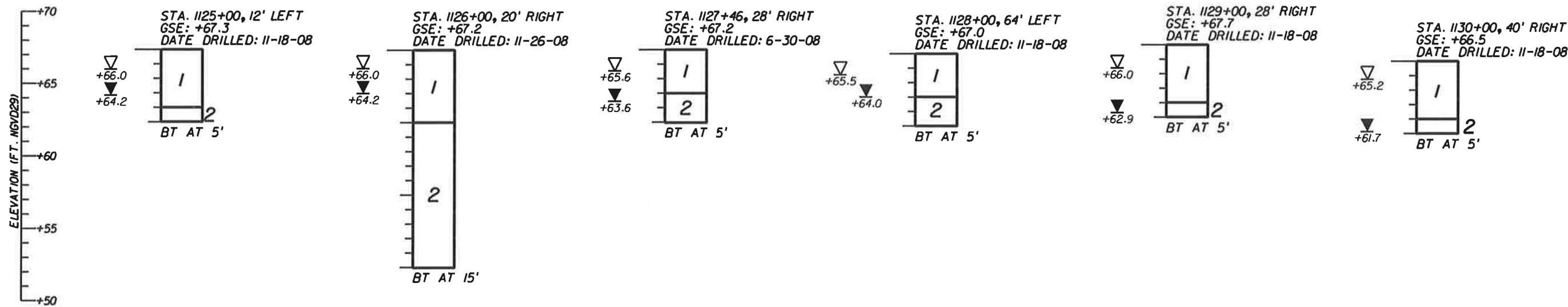

STRATUM NO.	AASHTO CLASSIFICATION	DESCRIPTION
1	A-3	BROWN FINE SAND TO FINE SAND WITH SILT, OCCASIONAL TRACE LIMEROCK
2	A-2-4	BROWN FINE SAND WITH SILT TO SILTY FINE SAND, OCCASIONAL TRACE ORGANIC MATERIAL
3	A-2-6, A-4, A-6	LIGHT BROWN CLAYEY FINE SAND, SANDY SILT AND SANDY CLAY

FIGURE 13

REVISIONS				Michael W. Byerly, P.E. P.E. License No. 52586 Geotechnical and Environmental Consultants, Inc. 2510 Michigan Avenue, Suite D Kissimmee, FL 34744-1933 PH (407) 483-1212 FAX (407) 932-2912 Certificate of Authorization No. 00005882	OSCEOLA COUNTY CIP PROJECT NO. 4331/4334			<b>AUGER BORING RESULTS</b>	SHEET NO.
DATE	DESCRIPTION	DATE	DESCRIPTION		COUNTY ROAD NO.	COUNTY	FINANCIAL PROJECT ID		
					525	OSCEOLA			

NOTICE: THE OFFICIAL RECORD OF THIS SHEET IS THE ELECTRONIC FILE SIGNED AND SEALED UNDER RULE 68G15-23.003, F.A.C.

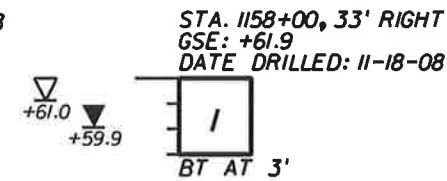
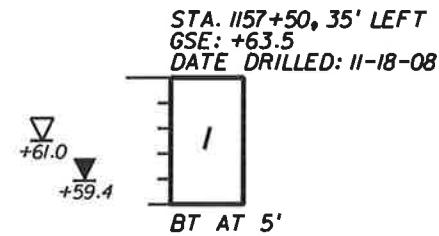
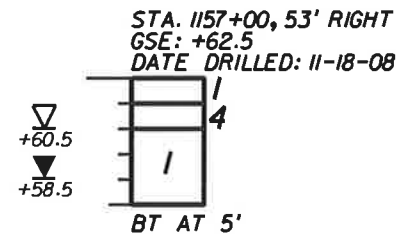
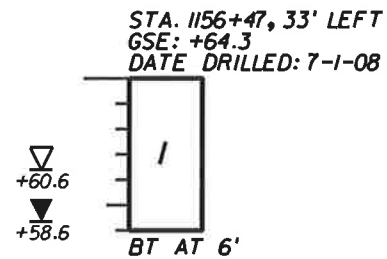
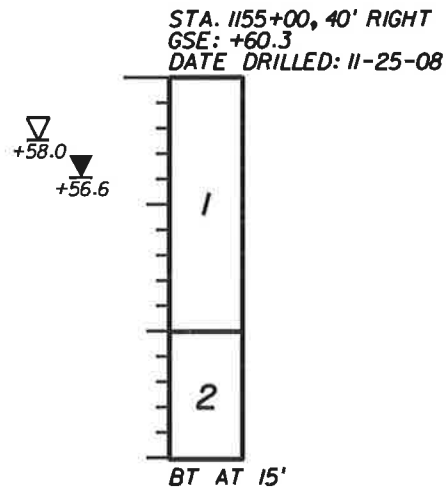
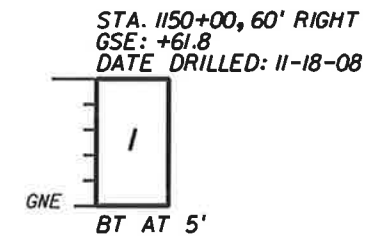
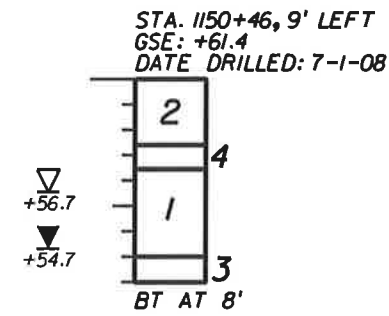
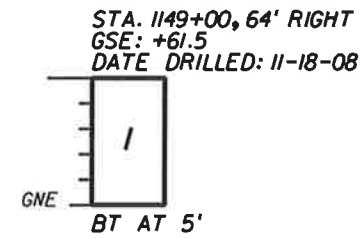
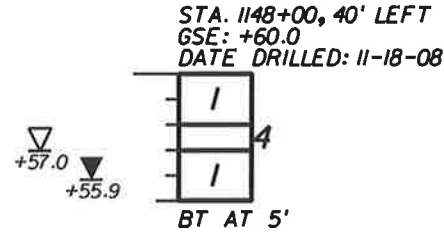
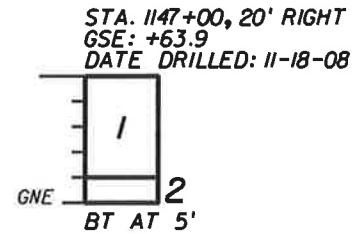
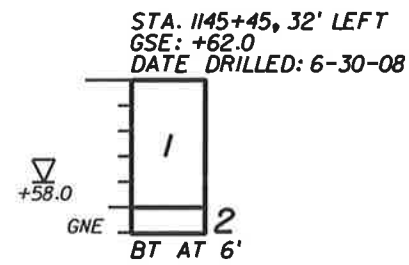

GROUND SURFACE ELEVATION (FT. NGVD29) → STA. 1156+47, 33' LEFT  
GSE: +64.3  
DATE DRILLED: 7-1-08

ESTIMATED SEASONAL HIGH GROUNDWATER ELEVATION (FT. NGVD29) → +60.6

ENCOUNTERED GROUNDWATER ELEVATION (FT. NGVD29) → +58.6

GROUNDWATER NOT ENCOUNTERED → GNE

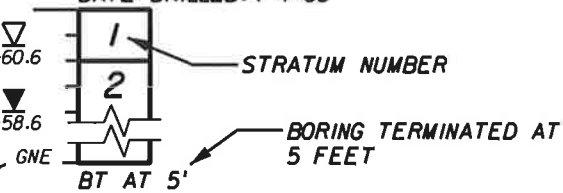

STRATUM NO.	AASHTO CLASSIFICATION	DESCRIPTION
1	A-3	BROWN FINE SAND TO FINE SAND WITH SILT, OCCASIONAL TRACE LIMEROCK
2	A-2-4	BROWN FINE SAND WITH SILT TO SILTY FINE SAND, OCCASIONAL TRACE ORGANIC MATERIAL
3	A-2-6, A-4, A-6	LIGHT BROWN CLAYEY FINE SAND, SANDY SILT AND SANDY CLAY
4	A-8	DARK BROWN MUCKY FINE SAND, SANDY MUCK AND MUCK

FIGURE 14

REVISIONS				Michael W. Byerly, P.E. P.E. License No. 52586 Geotechnical and Environmental Consultants, Inc. 2510 Michigan Avenue, Suite D Kissimmee, FL 34744-1933 PH (407) 483-1212 FAX (407) 932-2912 Certificate of Authorization No. 00005882	OSCEOLA COUNTY CIP PROJECT NO. 4331/4334			<b>AUGER BORING RESULTS</b>	SHEET NO.
DATE	DESCRIPTION	DATE	DESCRIPTION		COUNTY ROAD NO.	COUNTY	FINANCIAL PROJECT ID		
					525	OSCEOLA			

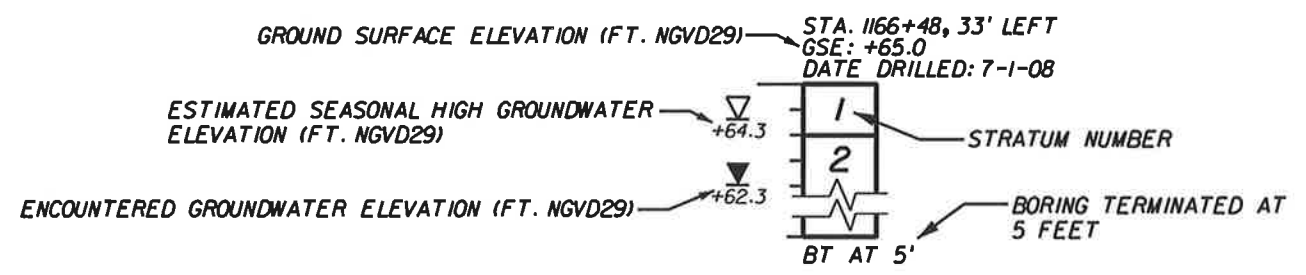
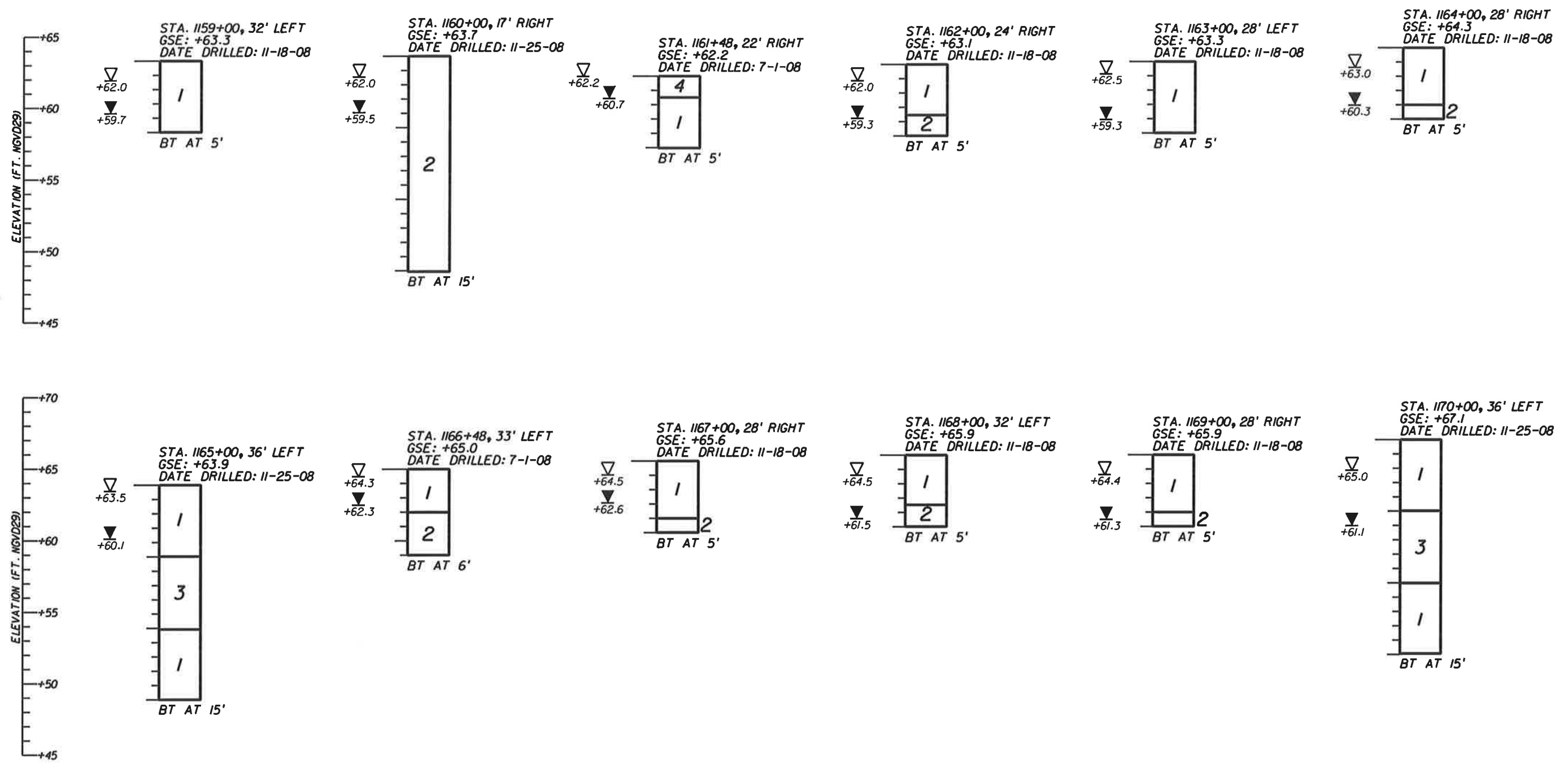

STRATUM NO.	AASHTO CLASSIFICATION	DESCRIPTION
1	A-3	BROWN FINE SAND TO FINE SAND WITH SILT, OCCASIONAL TRACE LIMEROCK
2	A-2-4	BROWN FINE SAND WITH SILT TO SILTY FINE SAND, OCCASIONAL TRACE ORGANIC MATERIAL
3	A-2-6, A-4, A-6	LIGHT BROWN CLAYEY FINE SAND, SANDY SILT AND SANDY CLAY
4	A-8	DARK BROWN MUCKY FINE SAND, SANDY MUCK AND MUCK

FIGURE 15

REVISIONS				Michael W. Byerly, P.E. P.E. License No. 52586 Geotechnical and Environmental Consultants, Inc. 2510 Michigan Avenue, Suite D Kissimmee, FL 34744-1933 PH (407) 483-1212 FAX (407) 932-2912 Certificate of Authorization No. 00005882	OSCEOLA COUNTY CIP PROJECT NO. 4331/4334			<b>AUGER BORING RESULTS</b>	SHEET NO.
DATE	DESCRIPTION	DATE	DESCRIPTION		COUNTY ROAD NO.	COUNTY	FINANCIAL PROJECT ID		
					525	OSCEOLA			

NOTICE: THE OFFICIAL RECORD OF THIS SHEET IS THE ELECTRONIC FILE SIGNED AND SEALED UNDER RULE 61G5-23.003, F.A.C.

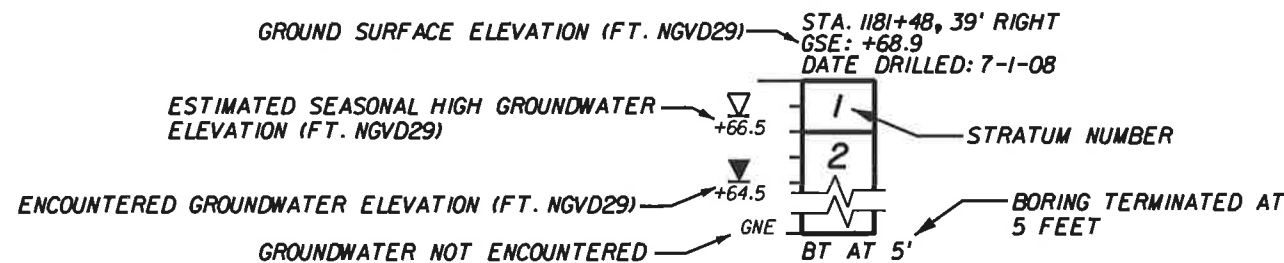
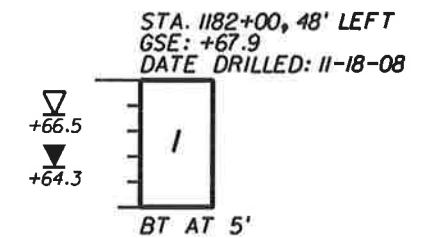
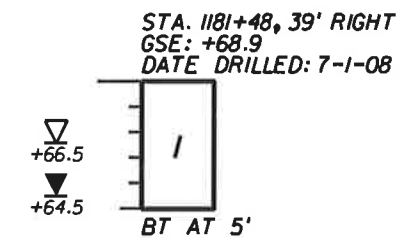
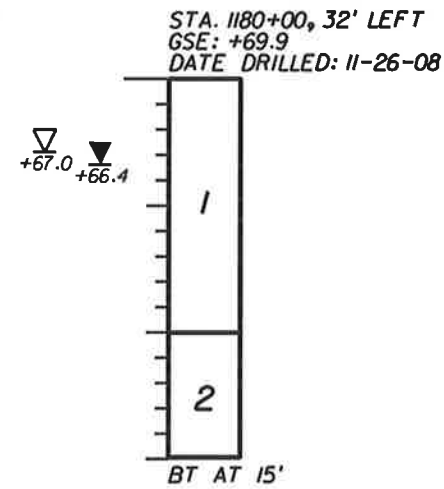
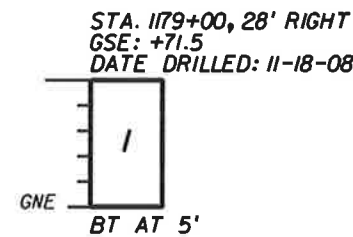
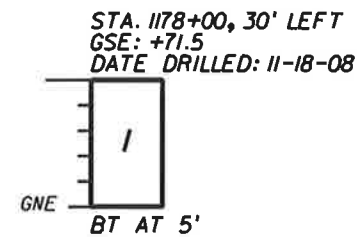
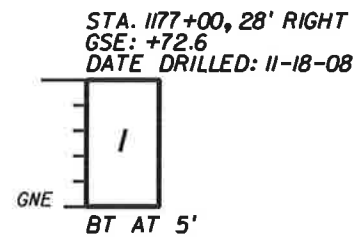
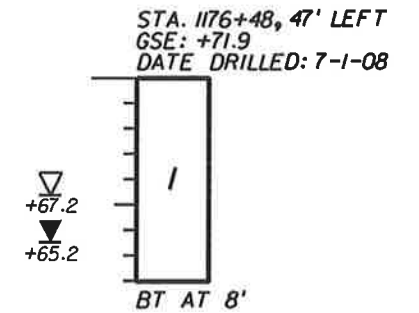
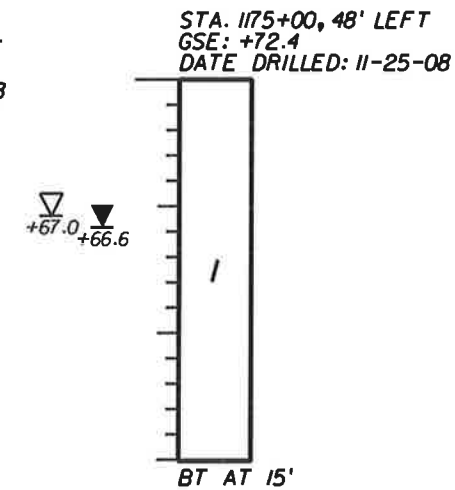
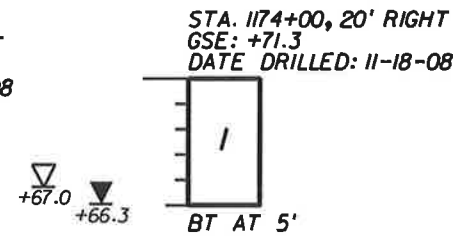
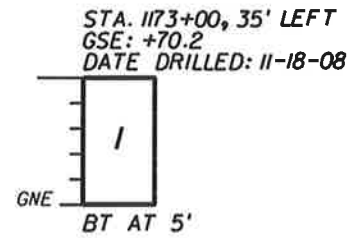
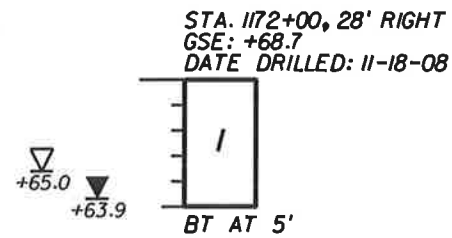
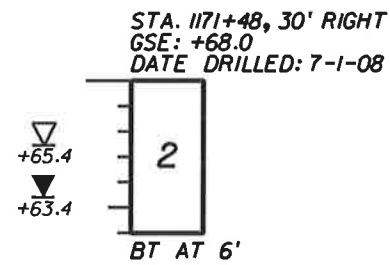

STRATUM NO.	AASHTO CLASSIFICATION	DESCRIPTION
1	A-3	BROWN FINE SAND TO FINE SAND WITH SILT, OCCASIONAL TRACE LIMESTONE
2	A-2-4	BROWN FINE SAND WITH SILT TO SILTY FINE SAND, OCCASIONAL TRACE ORGANIC MATERIAL

FIGURE 16

REVISIONS				Michael W. Byerly, P.E. P.E. License No. 52586 Geotechnical and Environmental Consultants, Inc. 2510 Michigan Avenue, Suite D Kissimmee, FL 34744-1933 PH (407) 483-1212 FAX (407) 932-2912 Certificate of Authorization No. 00005882	OSCEOLA COUNTY CIP PROJECT NO. 4331/4334			<b>AUGER BORING RESULTS</b>	SHEET NO.
DATE	DESCRIPTION	DATE	DESCRIPTION		COUNTY ROAD NO.	COUNTY	FINANCIAL PROJECT ID		
					525	OSCEOLA			

NOTICE: THE OFFICIAL RECORD OF THIS SHEET IS THE ELECTRONIC FILE SIGNED AND SEALED UNDER RULE 66G5-23.003, F.A.C.

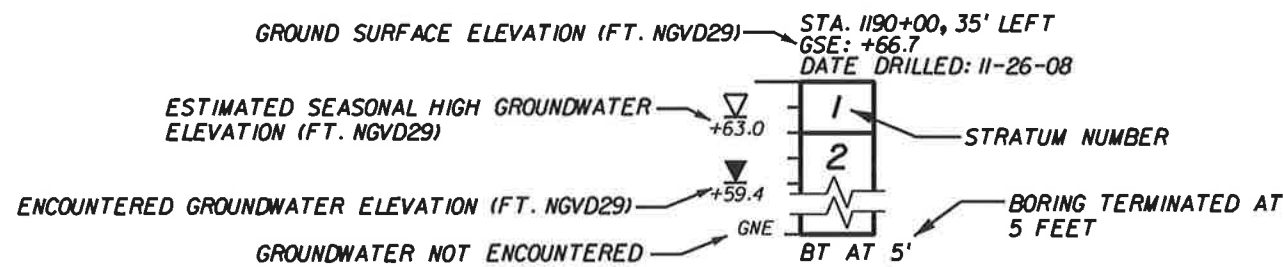
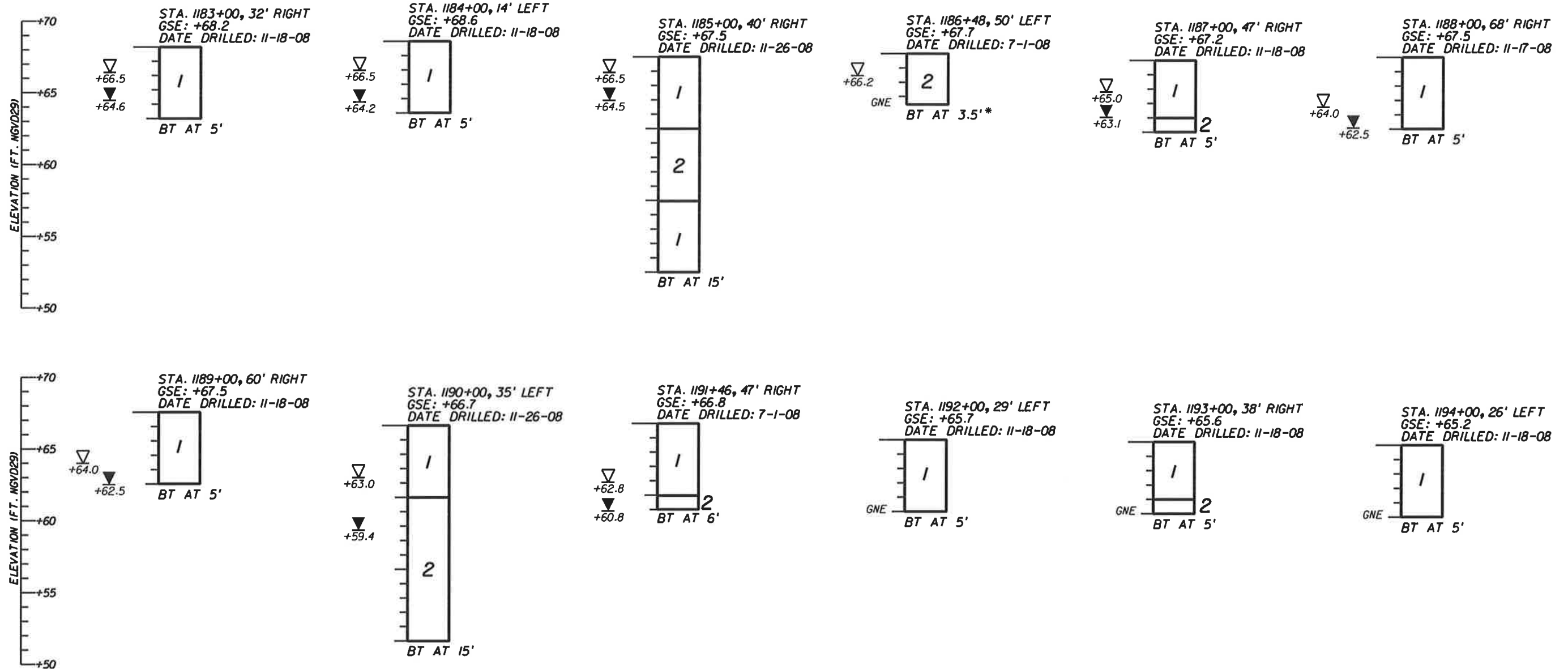

STRATUM NO.	AASHTO CLASSIFICATION	DESCRIPTION
1	A-3	BROWN FINE SAND TO FINE SAND WITH SILT, OCCASIONAL TRACE LIMEROCK
2	A-2-4	BROWN FINE SAND WITH SILT TO SILTY FINE SAND, OCCASIONAL TRACE ORGANIC MATERIAL

FIGURE 17

REVISIONS				Michael W. Byerly, P.E. P.E. License No. 52586 Geotechnical and Environmental Consultants, Inc. 2510 Michigan Avenue, Suite D Kissimmee, FL 34744-1933 PH (407) 483-1212 FAX (407) 932-2912 Certificate of Authorization No. 00005882	OSCEOLA COUNTY CIP PROJECT NO. 4331/434			<b>AUGER BORING RESULTS</b>	SHEET NO.
DATE	DESCRIPTION	DATE	DESCRIPTION		COUNTY ROAD NO.	COUNTY	FINANCIAL PROJECT ID		
					525	OSCEOLA			

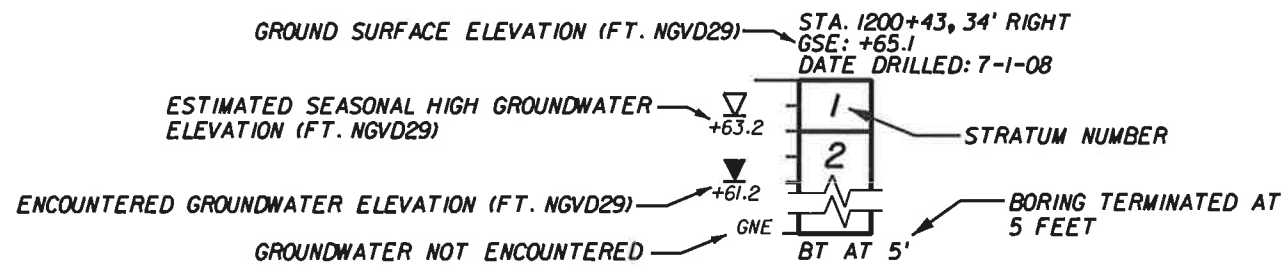
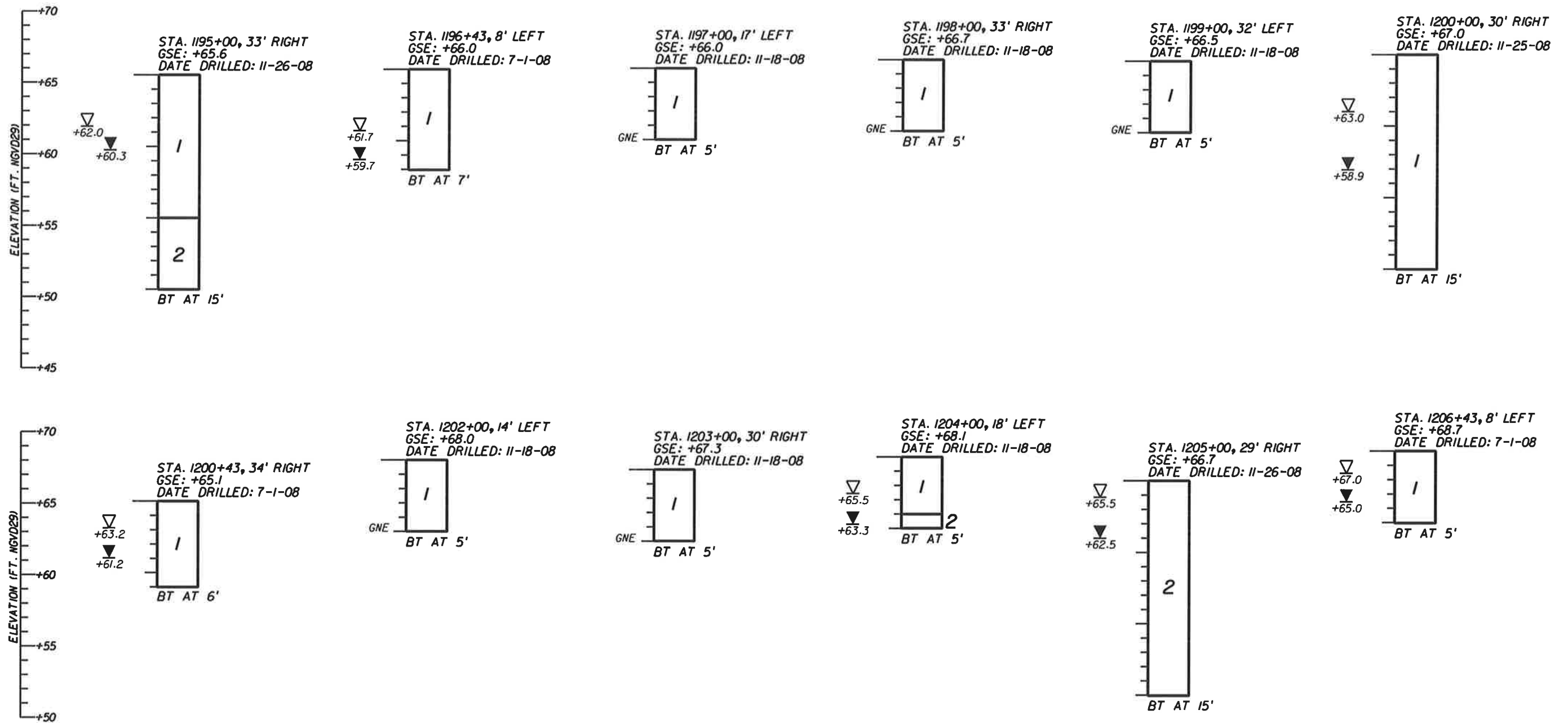

STRATUM NO.	AASHTO CLASSIFICATION	DESCRIPTION
1	A-3	BROWN FINE SAND TO FINE SAND WITH SILT, OCCASIONAL TRACE LIMEROCK
2	A-2-4	BROWN FINE SAND WITH SILT TO SILTY FINE SAND, OCCASIONAL TRACE ORGANIC MATERIAL

FIGURE 18

REVISIONS				Michael W. Beyerly, P.E. P.E. License No. 52586 Geotechnical and Environmental Consultants, Inc. 2510 Michigan Avenue, Suite D Kissimmee, FL 34744-1933 PH (407) 483-1212 FAX (407) 932-2912 Certificate of Authorization No. 00005882	OSCEOLA COUNTY CIP PROJECT NO. 4331/4334			<b>AUGER BORING RESULTS</b>	SHEET NO.
DATE	DESCRIPTION	DATE	DESCRIPTION		COUNTY ROAD NO.	COUNTY	FINANCIAL PROJECT ID		
					525	OSCEOLA			

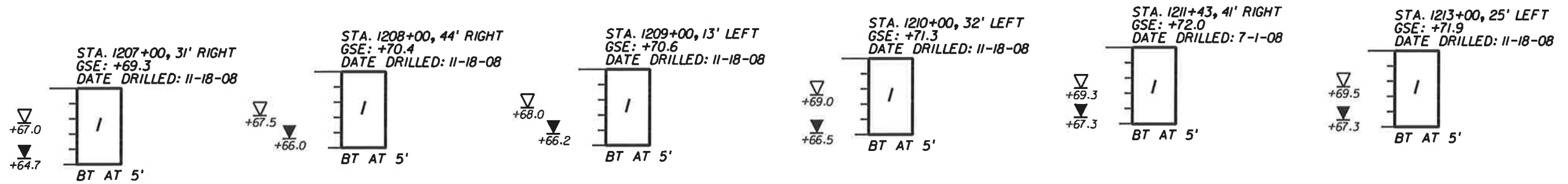

AMES HAVEN ROAD

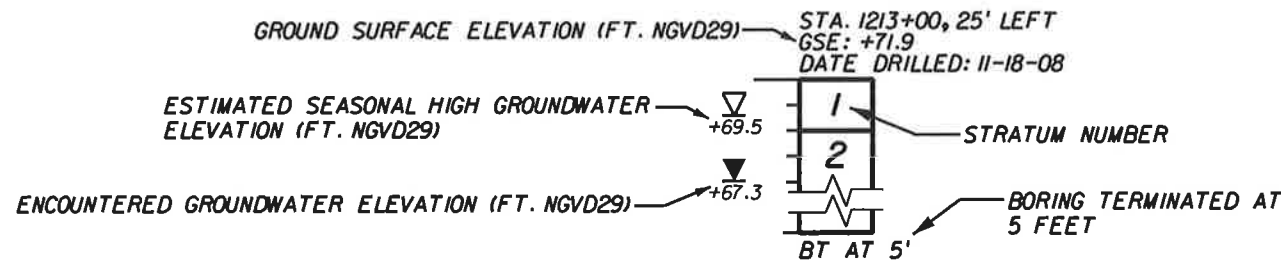
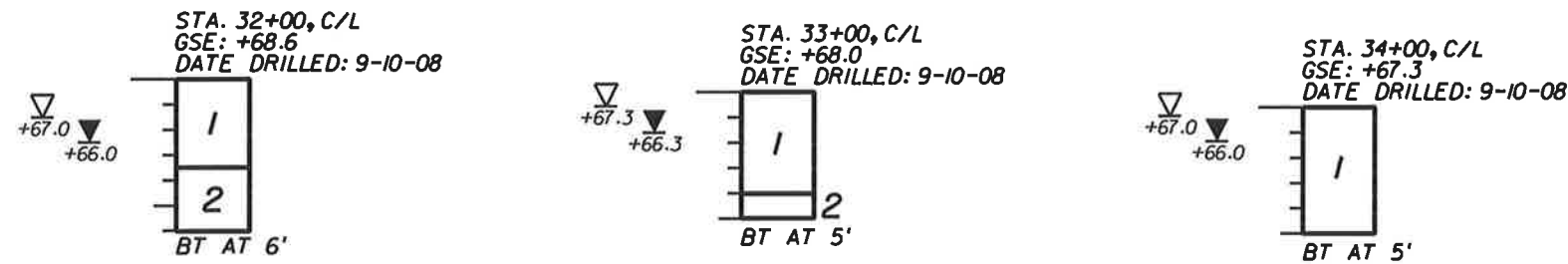

STRATUM NO.	AASHTO CLASSIFICATION	DESCRIPTION
1	A-3	BROWN FINE SAND TO FINE SAND WITH SILT, OCCASIONAL TRACE LIMEROCK
2	A-2-4	BROWN FINE SAND WITH SILT TO SILTY FINE SAND, OCCASIONAL TRACE ORGANIC MATERIAL

FIGURE 19

REVISIONS				Michael W. Byerly, P.E. P.E. License No. 52586 Geotechnical and Environmental Consultants, Inc. 2510 Michigan Avenue, Suite D Kissimmee, FL 34744-1933 PH (407) 483-1212 FAX (407) 932-2912 Certificate of Authorization No. 00005882	OSCEOLA COUNTY CIP PROJECT NO. 4331/4334			<b>AUGER BORING RESULTS</b>	SHEET NO.
DATE	DESCRIPTION	DATE	DESCRIPTION		COUNTY ROAD NO.	COUNTY	FINANCIAL PROJECT ID		
					525	OSCEOLA			

NOTICE: THE OFFICIAL RECORD OF THIS SHEET IS THE ELECTRONIC FILE SIGNED AND SEALED UNDER RULE 68G5-23.003, F.A.C.



## **POND AUGER BORING RESULTS**

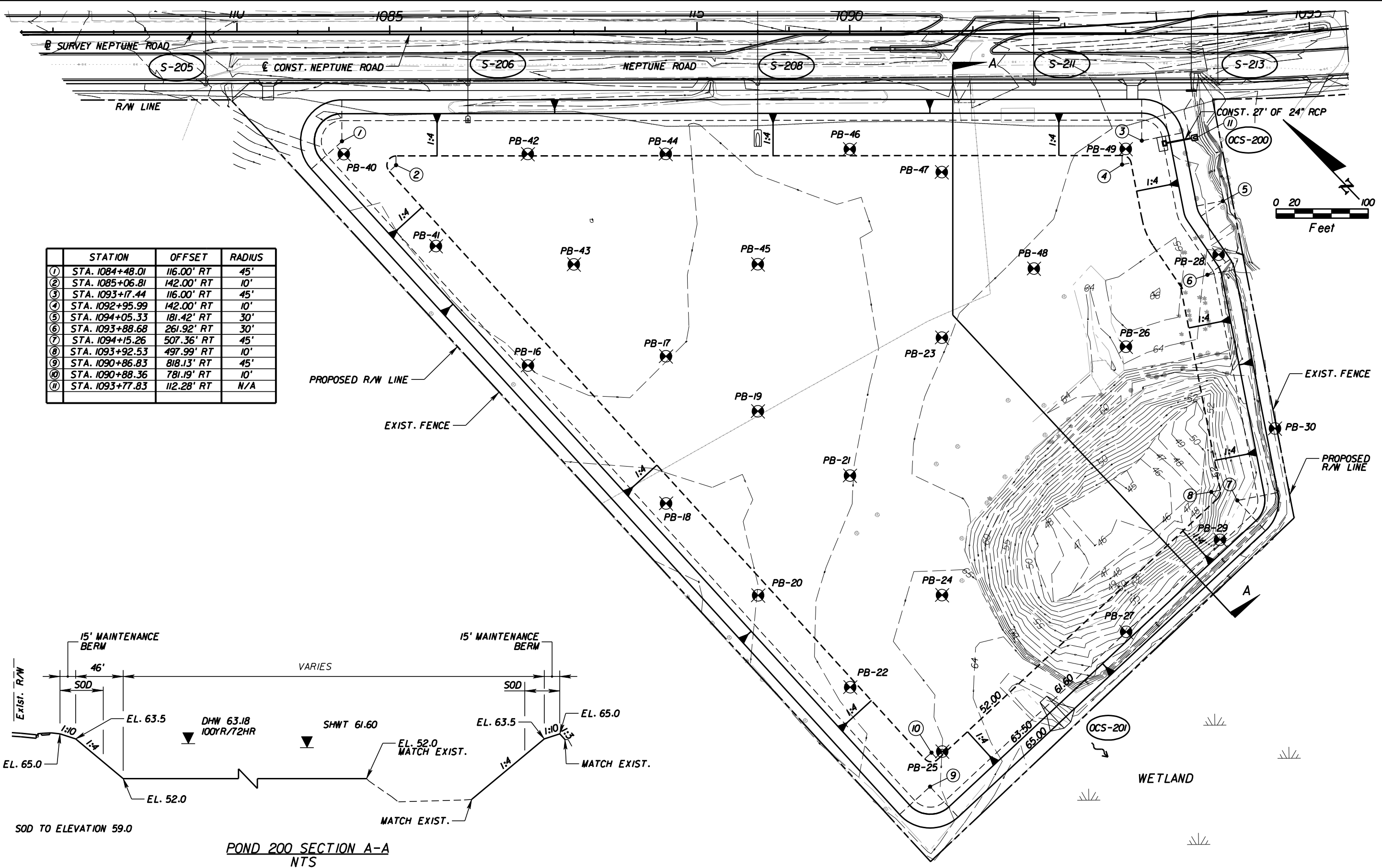

	STATION	OFFSET	RADIUS
①	STA. 1084+48.01	116.00' RT	45'
②	STA. 1085+06.81	142.00' RT	10'
③	STA. 1093+17.44	116.00' RT	45'
④	STA. 1092+95.99	142.00' RT	10'
⑤	STA. 1094+05.33	181.42' RT	30'
⑥	STA. 1093+88.68	261.92' RT	30'
⑦	STA. 1094+15.26	507.36' RT	45'
⑧	STA. 1093+92.53	497.99' RT	10'
⑨	STA. 1090+86.83	818.13' RT	45'
⑩	STA. 1090+88.36	781.19' RT	10'
Ⓜ	STA. 1093+77.83	112.28' RT	N/A

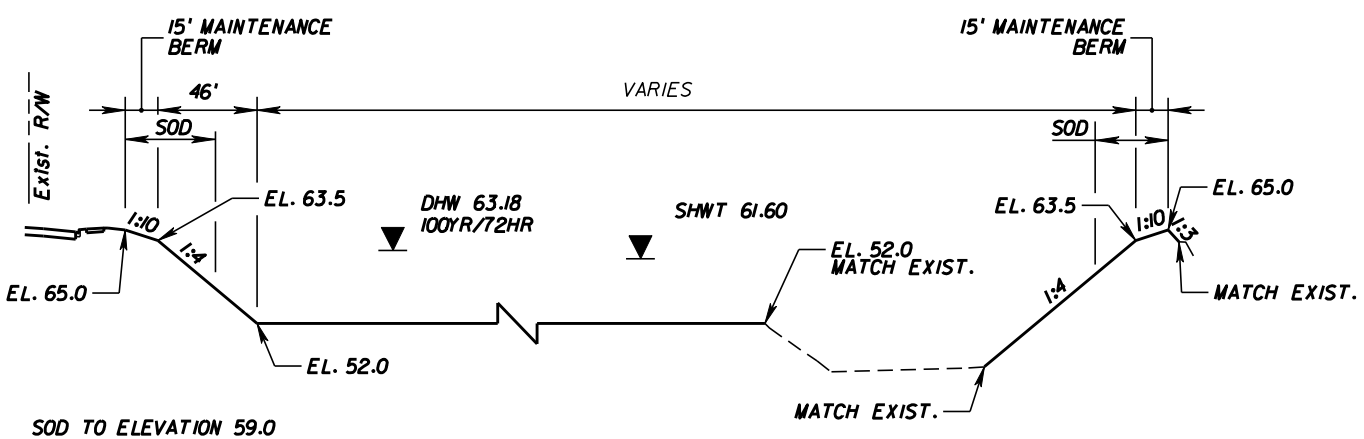

POND 200 SECTION A-A  
NTS

REVISIONS			
DATE	DESCRIPTION	DATE	DESCRIPTION

**Carter Burgess**  
 MURRAY B. SANTORO P.E.  
 P.E. LICENSE NO. 66065  
 1000 LEGION PLACE, SUITE 1400  
 ORLANDO, FLORIDA 32801  
 CERTIFICATE OF AUTHORIZATION No. 5300

OSCEOLA COUNTY FLORIDA		
ROAD NO.	COUNTY	CIP PROJECT NO.
C.R. 52	OSCEOLA	4331/4334

**POND 200 DETAIL SHEET**

SHEET NO.  
159

POND 200

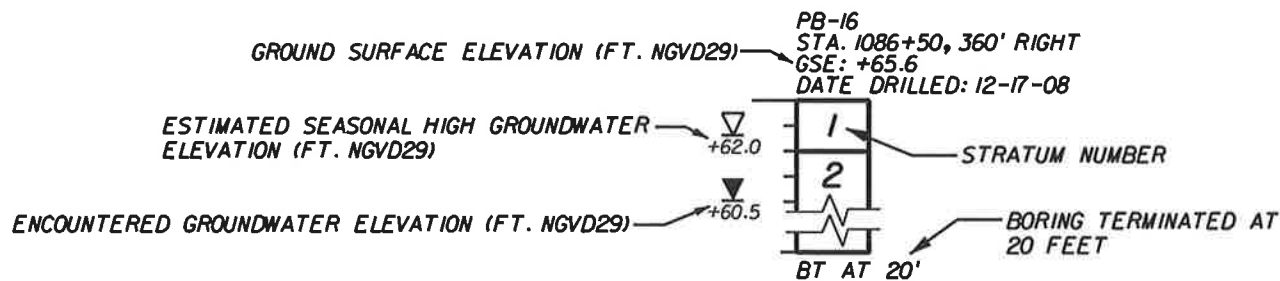
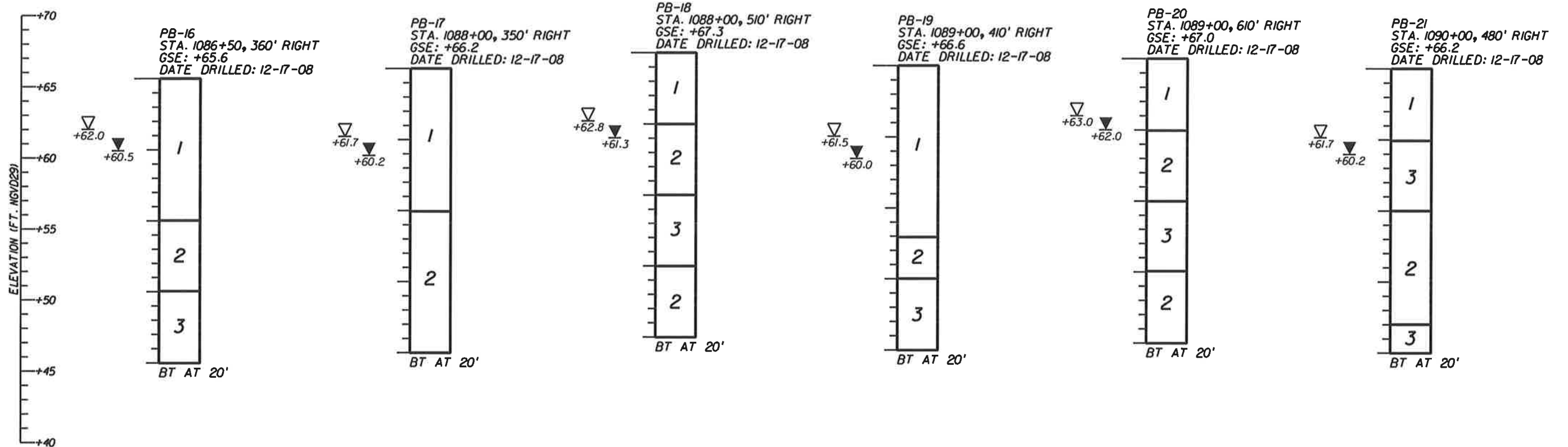

STRATUM NO.	AASHTO CLASSIFICATION	DESCRIPTION
1	A-3	BROWN FINE SAND TO FINE SAND WITH SILT, OCCASIONAL TRACE LIMEROCK
2	A-2-4	BROWN FINE SAND WITH SILT TO SILTY FINE SAND, OCCASIONAL TRACE ORGANIC MATERIAL
3	A-2-6, A-4, A-6	LIGHT BROWN CLAYEY FINE SAND, SANDY SILT AND SANDY CLAY

POND 200

FIGURE 23

REVISIONS				Michael W. Byerly, P.E. P.E. License No. 52586 Geotechnical and Environmental Consultants, Inc. 2510 Michigan Avenue, Suite D Kissimmee, FL 34744-1933 PH (407) 483-1212 FAX (407) 932-2912 Certificate of Authorization No. 00005882	OSCEOLA COUNTY CIP PROJECT NO. 4331/4334			<b>POND AUGER BORING RESULTS</b>	SHEET NO.
DATE	DESCRIPTION	DATE	DESCRIPTION		COUNTY ROAD NO.	COUNTY	FINANCIAL PROJECT ID		
					525	OSCEOLA			

sc011

1/28/2009

6:05:59 PM

J:\074\27876\13-09\Wboring02.dgn

NOTICE: THE OFFICIAL RECORD OF THIS SHEET IS THE ELECTRONIC FILE SIGNED AND SEALED UNDER RULE 68G15-23.003, F.A.C.

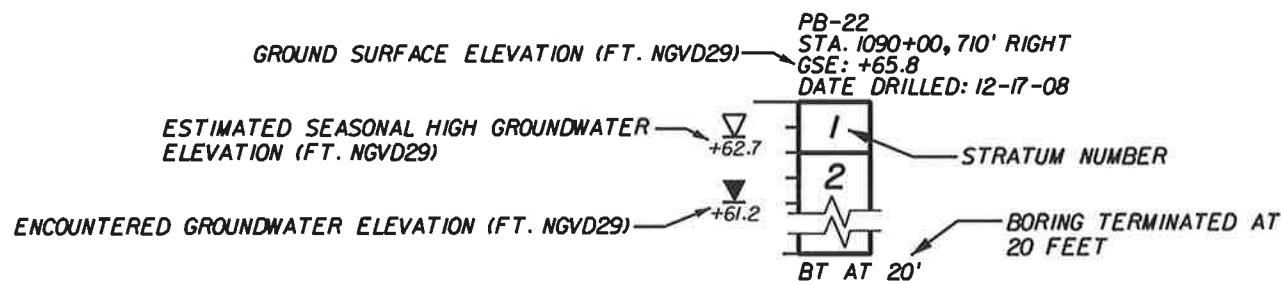
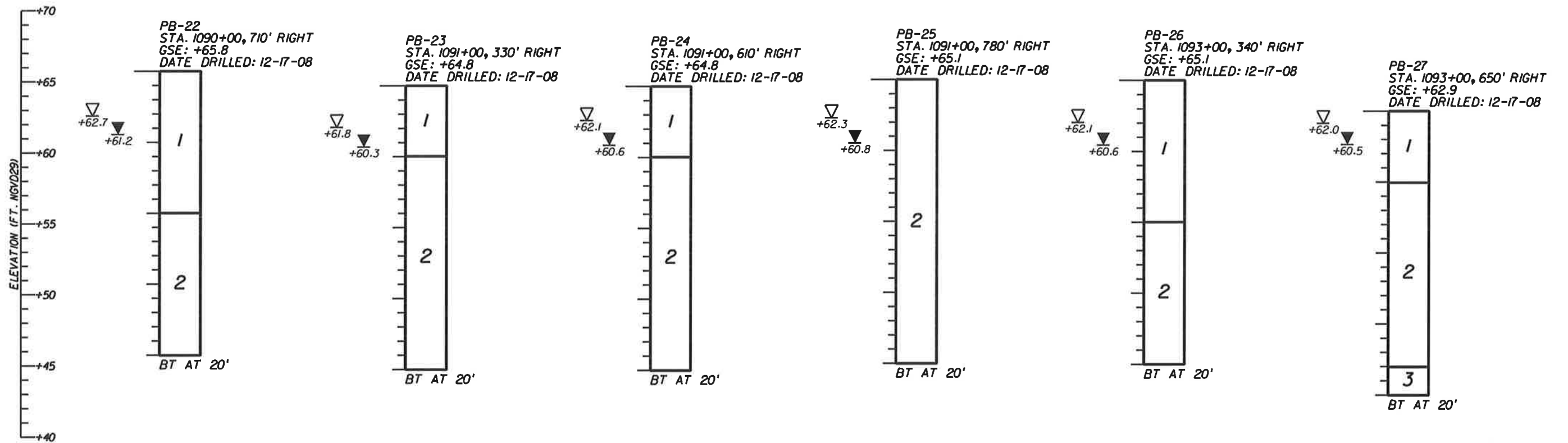

STRATUM NO.	AASHTO CLASSIFICATION	DESCRIPTION
1	A-3	BROWN FINE SAND TO FINE SAND WITH SILT, OCCASIONAL TRACE LIMEROCK
2	A-2-4	BROWN FINE SAND WITH SILT TO SILTY FINE SAND, OCCASIONAL TRACE ORGANIC MATERIAL
3	A-2-6, A-4, A-6	LIGHT BROWN CLAYEY FINE SAND, SANDY SILT AND SANDY CLAY

POND 200

FIGURE 24

REVISIONS				Michael W. Byerly, P.E. P.E. License No. 52586 Geotechnical and Environmental Consultants, Inc. 2510 Michigan Avenue, Suite D Kissimmee, FL 34744-1933 PH (407) 483-1212 FAX (407) 932-2912 Certificate of Authorization No. 00005882	OSCEOLA COUNTY CIP PROJECT NO. 4331/4334			<b>POND AUGER BORING RESULTS</b>	SHEET NO.
DATE	DESCRIPTION	DATE	DESCRIPTION		COUNTY ROAD NO.	COUNTY	FINANCIAL PROJECT ID		
					525	OSCEOLA			

sc011

1/28/2009

6:06:07 PM

J:\074\27876V-13-09\boring02.dgn

NOTICE: THE OFFICIAL RECORD OF THIS SHEET IS THE ELECTRONIC FILE SIGNED AND SEALED UNDER RULE 6815-23.003, F.A.C.

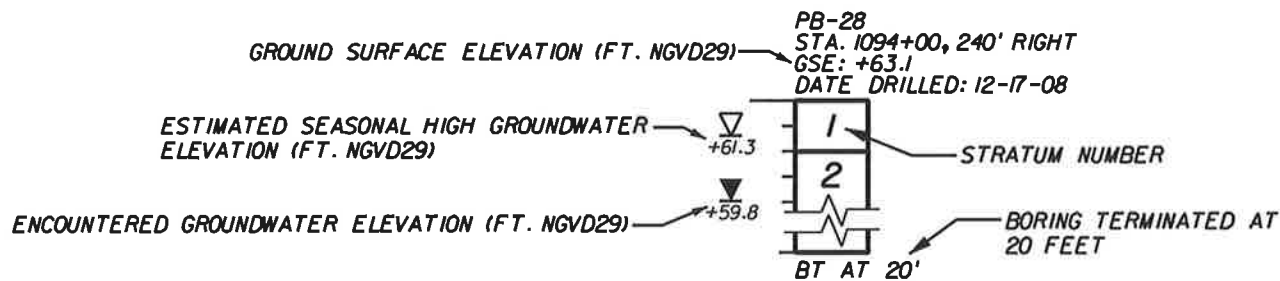
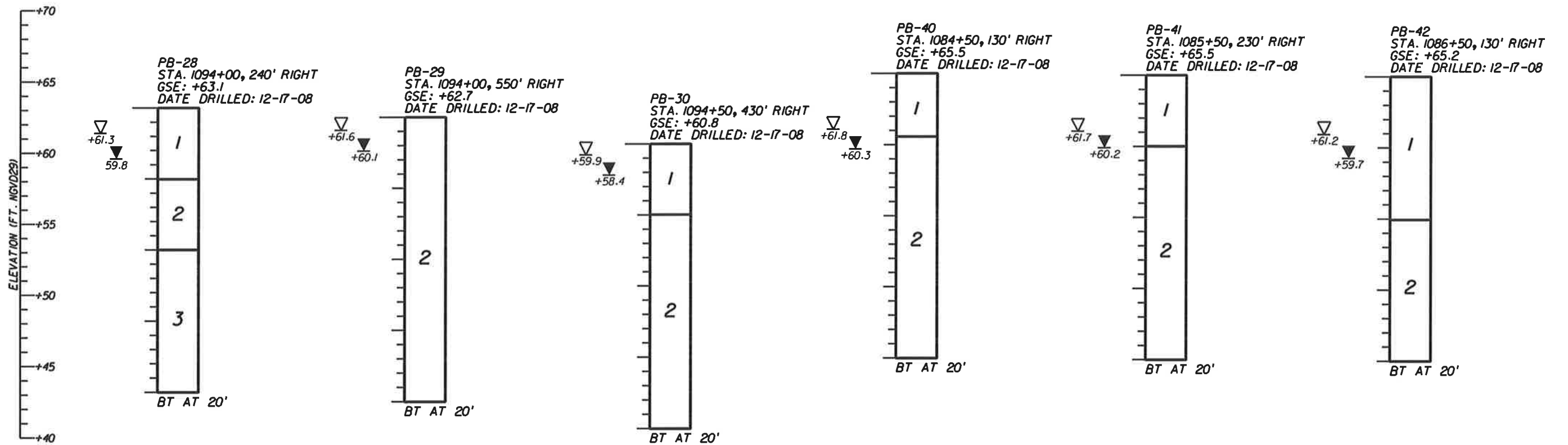

STRATUM NO.	AASHTO CLASSIFICATION	DESCRIPTION
1	A-3	BROWN FINE SAND TO FINE SAND WITH SILT, OCCASIONAL TRACE LIMEROCK
2	A-2-4	BROWN FINE SAND WITH SILT TO SILTY FINE SAND, OCCASIONAL TRACE ORGANIC MATERIAL
3	A-2-6, A-4, A-6	LIGHT BROWN CLAYEY FINE SAND, SANDY SILT AND SANDY CLAY

POND 200

FIGURE 25

REVISIONS				Michael W. Byerly, P.E. P.E. License No. 52586 Geotechnical and Environmental Consultants, Inc. 2510 Michigan Avenue, Suite D Kissimmee, FL 34744-1933 PH (407) 483-1212 FAX (407) 932-2912 Certificate of Authorization No. 00005882	OSCEOLA COUNTY CIP PROJECT NO. 4331/4334			<b>POND AUGER BORING RESULTS</b>	SHEET NO.
DATE	DESCRIPTION	DATE	DESCRIPTION		COUNTY ROAD NO.	COUNTY	FINANCIAL PROJECT ID		
					525	OSCEOLA			

sc011

1/28/2009

6:45:12 PM

J:\DTA\27876V-13-09\Boring02.dgn

NOTICE: THE OFFICIAL RECORD OF THIS SHEET IS THE ELECTRONIC FILE SIGNED AND SEALED UNDER RULE 68G15-23.003, F.A.C.

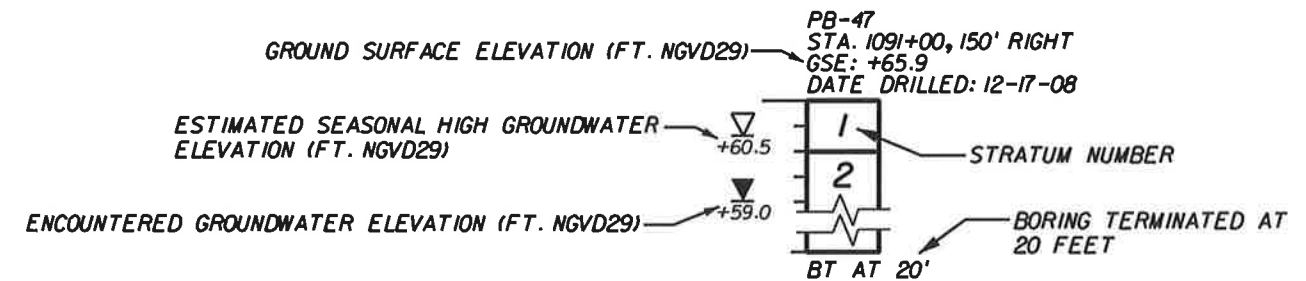
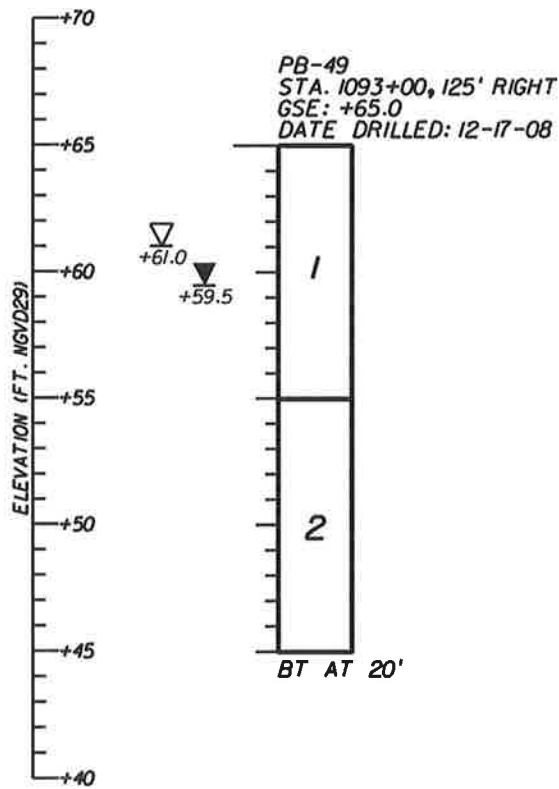
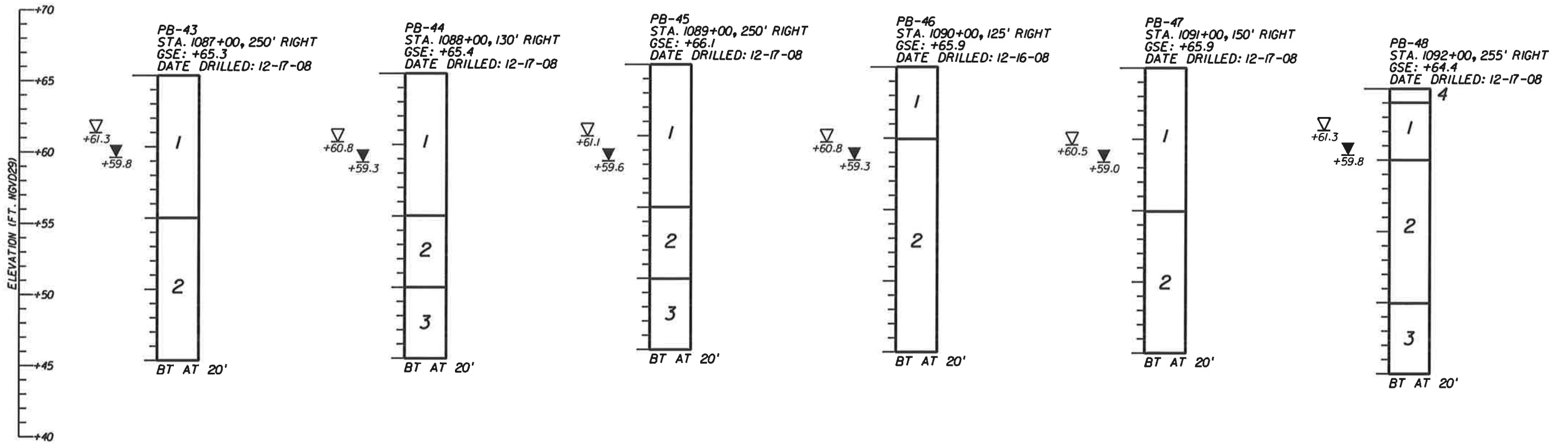

STRATUM NO.	AASHTO CLASSIFICATION	DESCRIPTION
1	A-3	BROWN FINE SAND TO FINE SAND WITH SILT, OCCASIONAL TRACE LIMEROCK
2	A-2-4	BROWN FINE SAND WITH SILT TO SILTY FINE SAND, OCCASIONAL TRACE ORGANIC MATERIAL
3	A-2-6, A-4, A-6	LIGHT BROWN CLAYEY FINE SAND, SANDY SILT AND SANDY CLAY
4	A-8	DARK BROWN MUCKY FINE SAND, SANDY MUCK AND MUCK

POND 200

FIGURE 26

REVISIONS				Michael W. Byerly, P.E. P.E. License No. 52586 Geotechnical and Environmental Consultants, Inc. 2510 Michigan Avenue, Suite D Kissimmee, FL 34744-1933 PH (407) 483-1212 FAX (407) 932-2912 Certificate of Authorization No. 00005882	OSCEOLA COUNTY CIP PROJECT NO. 4331/4334			<b>POND AUGER BORING RESULTS</b>	SHEET NO.
DATE	DESCRIPTION	DATE	DESCRIPTION		COUNTY ROAD NO.	COUNTY	FINANCIAL PROJECT ID		
					525	OSCEOLA			

sc011

1/28/2009

6:45:20 PM

J:\074\278764-13-09\boring02.dgn

NOTICE: THE OFFICIAL RECORD OF THIS SHEET IS THE ELECTRONIC FILE SIGNED AND SEALED UNDER RULE 6815-23.003, F.A.C.

**REPORT OF SPT BORINGS  
FOR HIGH FILL EMBANKMENT**

**LEGEND**

- GSE GROUND SURFACE ELEVATION (FT. NGVD29)
- ▽ ESTIMATED SEASONAL HIGH GROUNDWATER ELEVATION AT OR ABOVE EXISTING GROUND SURFACE (FT. NGVD29)
- ▽ ENCOUNTERED GROUNDWATER ELEVATION (FT. NGVD29)
- N STANDARD PENETRATION RESISTANCE, BLOWS PER FOOT
- (SP) UNIFIED SOIL CLASSIFICATION SYMBOL
- HA HAND AUGERED FOR UTILITY CLEARANCE
- BT BORING TERMINATED AT SPECIFIED DEPTH (FT.) INDICATED
- 200= PERCENT PASSING NO. 200 U.S. STANDARD SIEVE (FM 1-T 088)
- MC= NATURAL MOISTURE CONTENT (%) (FM 1-T 265)
- LL= LIQUID LIMIT (FM 1-T 089)
- PI= PLASTICITY INDEX (FM 1-T 090)
- OC= PERCENT ORGANIC CONTENT (FM 1-T 267)

**SOILS LEGEND**

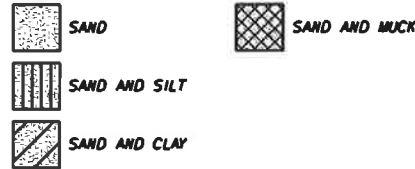

**GENERAL NOTES**

STANDARD PENETRATION TEST BORINGS WERE PERFORMED IN ACCORDANCE WITH ASTM D-1586. STANDARD PENETRATION RESISTANCES ARE SHOWN ON THE BORINGS AT THE TEST DEPTHS IN BLOWS PER FOOT UNLESS OTHERWISE NOTED.

SUBSURFACE CONDITIONS SHOWN ON THE BORINGS REPRESENT THE CONDITIONS ENCOUNTERED AT THE BORING LOCATIONS. ACTUAL CONDITIONS BETWEEN BORINGS MAY VARY FROM THOSE SHOWN. UNIFIED SOIL CLASSIFICATIONS SHOWN ON THE BORINGS ARE BASED ON VISUAL EXAMINATION AND THE LABORATORY TESTING SHOWN.

THE BORING LOCATIONS WERE SURVEYED BY JOHNSTON'S SURVEYING, INC. FOR VERTICAL AND HORIZONTAL CONTROL. THE BORING LOCATIONS ARE REFERENCED TO THE CENTERLINE OF CONSTRUCTION.

BASED ON REVIEW OF THE U.S. GEOLOGICAL SURVEY MAP ENTITLED "POTENTIOMETRIC SURFACE OF THE UPPER FLORIDAN AQUIFER IN THE ST. JOHNS RIVER WATER MANAGEMENT DISTRICT AND VICINITY, FLORIDA, SEPTEMBER 2007" FOR THE PROJECT AREA, THE MAXIMUM ELEVATION OF THE ARTESIAN HEAD IS ESTIMATED TO BE APPROXIMATELY +44 FT. NGVD. THE CONTRACTOR SHALL BE PREPARED TO HANDLE ARTESIAN HEAD LEVELS UP TO +44 FT. NGVD.

SPLIT SPOON SAMPLER:  
INSIDE DIAMETER: 1.375 IN.      HAMMER WEIGHT: 140 LBS.  
OUTSIDE DIAMETER: 2.0 IN.      HAMMER TYPE: SAFETY (MANUAL)  
AVERAGE HAMMER DROP: 30 IN.

ENVIRONMENTAL CLASSIFICATION:  
SUPERSTRUCTURE: SLIGHTLY AGGRESSIVE  
SUBSTRUCTURE: STEEL: MODERATELY AGGRESSIVE  
CONCRETE: SLIGHTLY AGGRESSIVE

**CORRELATION OF STANDARD PENETRATION RESISTANCE WITH RELATIVE DENSITY AND CONSISTENCY OF SOIL**

GRANULAR SOILS	N VALUE (blows per foot)	RELATIVE DENSITY
GRANULAR SOILS	0-4	VERY LOOSE
	4-10	LOOSE
	10-30	MEDIUM DENSE
	30-50	DENSE
	OVER 50	VERY DENSE
NON-GRANULAR SOILS	N VALUE (blows per foot)	CONSISTENCY
SILTS, CLAYS, MUCK, PEAT	0-2	VERY SOFT
	2-4	SOFT
	4-8	FIRM
	8-15	STIFF
	15-30	VERY STIFF
	OVER 30	HARD

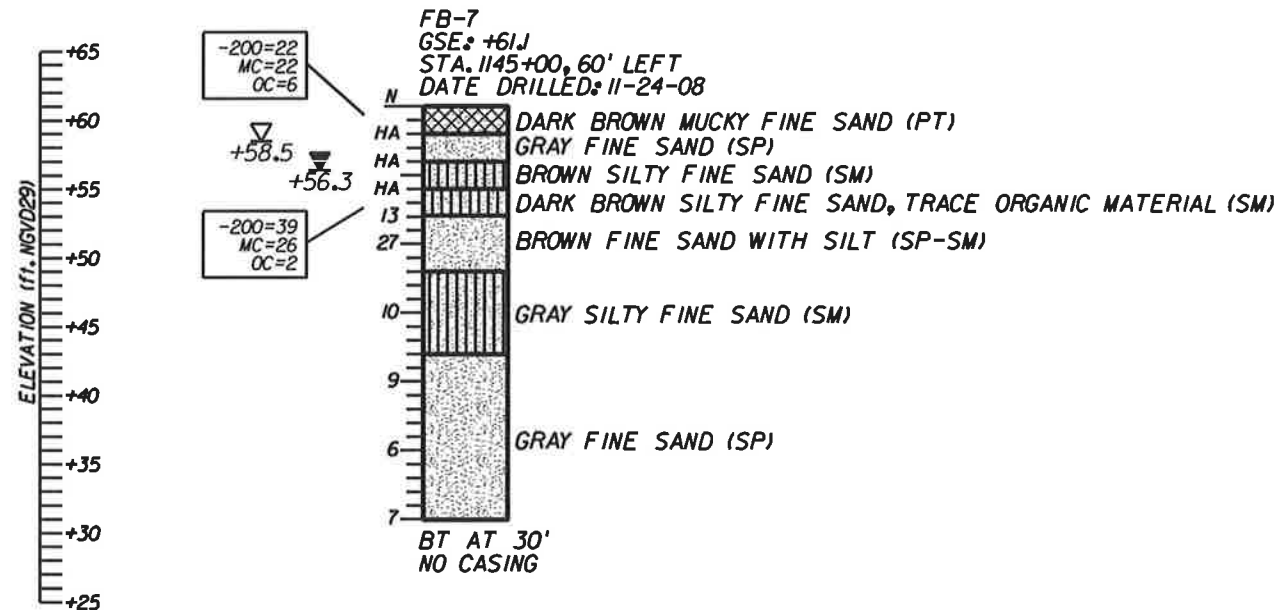
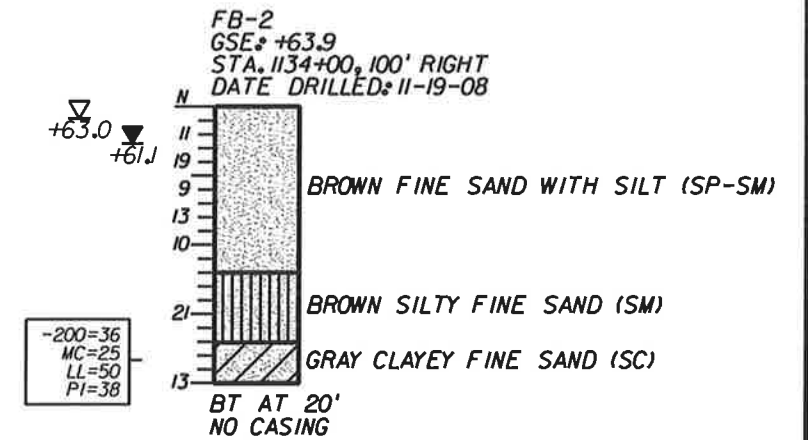
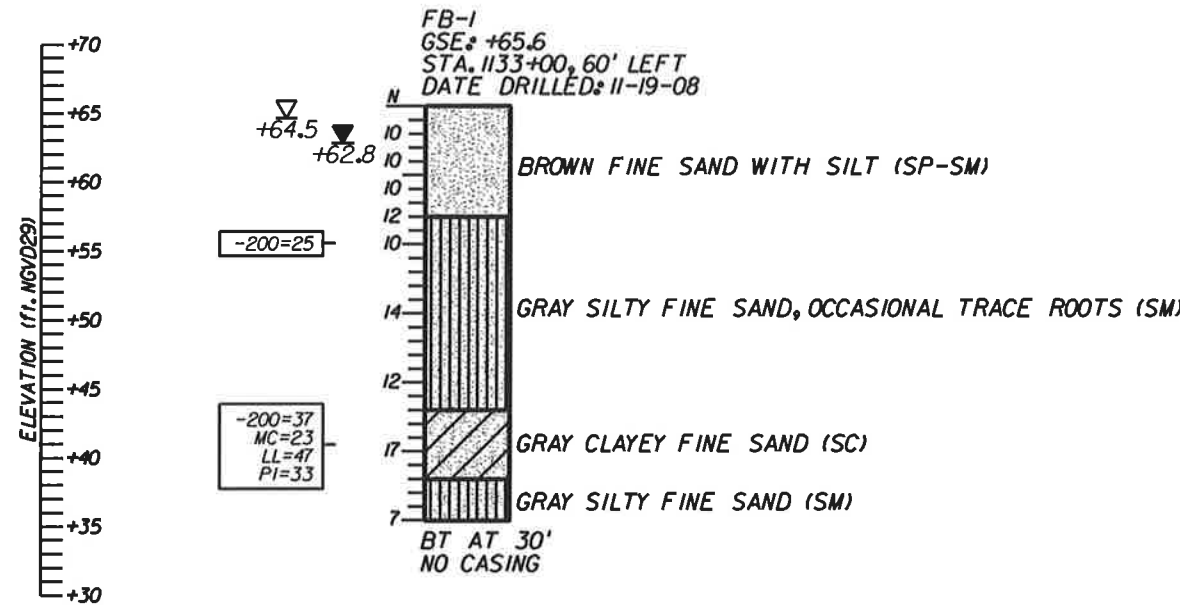

FIGURE 27

REVISIONS						Michael W. Beryl, P.E. P.E. License No. 52586 Geotechnical and Environmental Consultants, Inc. 2510 Michigan Avenue, Suite D Kissimmee, FL 34744 PH (407) 483-1212 FAX (407) 932-2912 Certificate of Authorization No. 00005882	OSCEOLA COUNTY CIP PROJECT NO. 4331/4334			REPORT OF SPT BORINGS FOR HIGH FILL EMBANKMENT	SHEET NO.
DATE	BY	DESCRIPTION	DATE	BY	DESCRIPTION		ROAD NO.	COUNTY	FINANCIAL PROJECT ID		
						525	OSCEOLA				

NOTICE: THE OFFICIAL RECORD OF THIS SHEET IS THE ELECTRONIC FILE SIGNED AND SEALED UNDER RULE 68G5-23.003, F.A.C.



**LEGEND**

- GSE GROUND SURFACE ELEVATION (FT. NGVD29)
- ▽ ESTIMATED SEASONAL HIGH GROUNDWATER ELEVATION AT OR ABOVE EXISTING GROUND SURFACE (FT. NGVD29)
- ▽ ENCOUNTERED GROUNDWATER ELEVATION (FT. NGVD29)
- N STANDARD PENETRATION RESISTANCE, BLOWS PER FOOT
- (SP) UNIFIED SOIL CLASSIFICATION SYMBOL
- HA HAND AUGERED FOR UTILITY CLEARANCE
- BT BORING TERMINATED AT SPECIFIED DEPTH (FT.) INDICATED
- 200= PERCENT PASSING NO. 200 U.S. STANDARD SIEVE (FM I-T 088)
- MC= NATURAL MOISTURE CONTENT (%) (FM I-T 265)
- OC= PERCENT ORGANIC CONTENT (FM I-T 267)

**SOILS LEGEND**

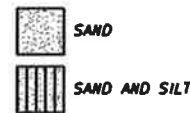

**GENERAL NOTES**

STANDARD PENETRATION TEST BORINGS WERE PERFORMED IN ACCORDANCE WITH ASTM D-1586. STANDARD PENETRATION RESISTANCES ARE SHOWN ON THE BORINGS AT THE TEST DEPTHS IN BLOWS PER FOOT UNLESS OTHERWISE NOTED.

SUBSURFACE CONDITIONS SHOWN ON THE BORINGS REPRESENT THE CONDITIONS ENCOUNTERED AT THE BORING LOCATIONS. ACTUAL CONDITIONS BETWEEN BORINGS MAY VARY FROM THOSE SHOWN. UNIFIED SOIL CLASSIFICATIONS SHOWN ON THE BORINGS ARE BASED ON VISUAL EXAMINATION AND THE LABORATORY TESTING SHOWN.

THE BORING LOCATIONS WERE SURVEYED BY JOHNSTON'S SURVEYING, INC. FOR VERTICAL AND HORIZONTAL CONTROL. THE BORING LOCATIONS ARE REFERENCED TO THE CENTERLINE OF CONSTRUCTION.

BASED ON REVIEW OF THE U.S. GEOLOGICAL SURVEY MAP ENTITLED "POTENTIOMETRIC SURFACE OF THE UPPER FLORIDAN AQUIFER IN THE ST. JOHNS RIVER WATER MANAGEMENT DISTRICT AND VICINITY, FLORIDA, SEPTEMBER 2007" FOR THE PROJECT AREA, THE MAXIMUM ELEVATION OF THE ARTESIAN HEAD IS ESTIMATED TO BE APPROXIMATELY +44 FT. NGVD. THE CONTRACTOR SHALL BE PREPARED TO HANDLE ARTESIAN HEAD LEVELS UP TO +44 FT. NGVD.

SPLIT SPOON SAMPLER:  
 INSIDE DIAMETER: 1.375 IN. HAMMER WEIGHT: 140 LBS.  
 OUTSIDE DIAMETER: 2.0 IN. HAMMER TYPE: SAFETY (MANUAL)  
 AVERAGE HAMMER DROP: 30 IN.

ENVIRONMENTAL CLASSIFICATION:  
 SUPERSTRUCTURE: SLIGHTLY AGGRESSIVE  
 SUBSTRUCTURE: STEEL: MODERATELY AGGRESSIVE  
 CONCRETE: SLIGHTLY AGGRESSIVE

**CORRELATION OF STANDARD PENETRATION RESISTANCE WITH RELATIVE DENSITY AND CONSISTENCY OF SOIL**

GRANULAR SOILS	N VALUE (blows per foot)	RELATIVE DENSITY
GRANULAR SOILS	0-4	VERY LOOSE
	4-10	LOOSE
	10-30	MEDIUM DENSE
	30-50	DENSE
	OVER 50	VERY DENSE
NON-GRANULAR SOILS	N VALUE (blows per foot)	CONSISTENCY
SILTS, CLAYS, MUCK, PEAT	0-2	VERY SOFT
	2-4	SOFT
	4-8	FIRM
	8-15	STIFF
	15-30	VERY STIFF
	OVER 30	HARD

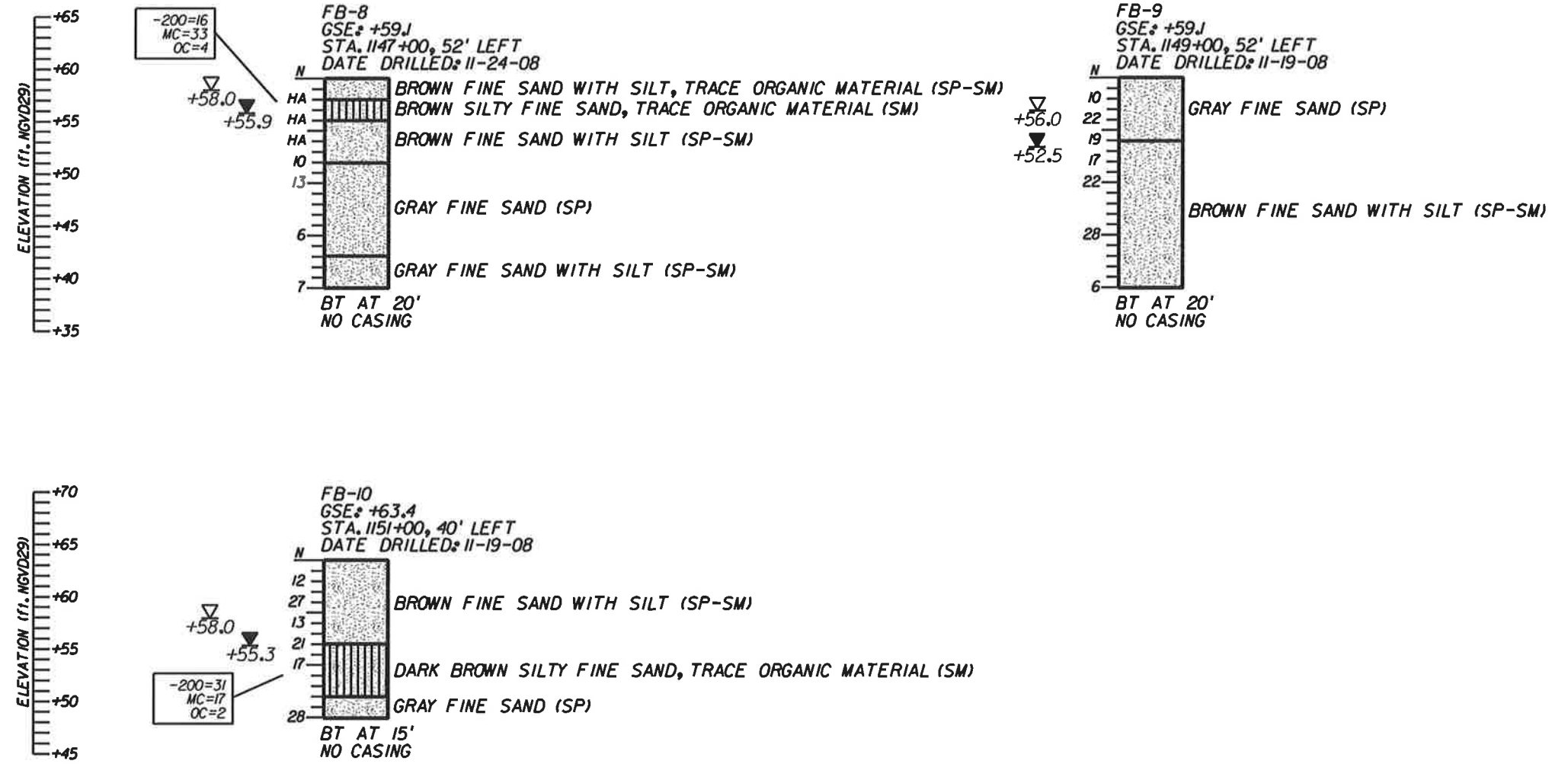

FIGURE 28

REVISIONS						Michael W. Byerly, P.E. P.E. License No. 52586 Geotechnical and Environmental Consultants, Inc. 2510 Michigan Avenue, Suite D Kissimmee, FL 34744 PH (407) 483-1212 FAX (407) 932-2912 Certificate of Authorization No. 00005882	OSCEOLA COUNTY CIP PROJECT NO. 4331/4334			SHEET NO.
DATE	BY	DESCRIPTION	DATE	BY	DESCRIPTION		ROAD NO.	COUNTY	FINANCIAL PROJECT ID	
							525	OSCEOLA		

**REPORT OF SPT BORINGS FOR HIGH FILL EMBANKMENT**

NOTICE: THE OFFICIAL RECORD OF THIS SHEET IS THE ELECTRONIC FILE SIGNED AND SEALED UNDER RULE 68G5-23.003, F.A.C.